



2.4/5 GHz Dual-Band 1x1 Wi-Fi® 5 (802.11ac) + Bluetooth® 5.4 + 802.15.4 Tri-radio Solution

IW512

Last Updated: Feb 13, 2025

The IW512 is a highly integrated 2.4/5 GHz dual-band 1x1 Wi-Fi 5, Bluetooth/Bluetooth Low Energy 5.4 and 802.15.4 tri-radio single-chip solution optimized for a broad array of IoT applications in smart home, smart devices and accessories, smart appliances, smart energy, industrial automation, gateways and many more. This high degree of integration contributes to very low system costs and a minimum external BOM while achieving efficient coexistence between all internal radios as well as external radios, such as LTE.

IW512 includes a full-feature Wi-Fi subsystem powered by NXP's 802.11ac (Wi-Fi 5) technology bringing higher throughput over previous generation Wi-Fi standards. The Wi-Fi subsystem integrates a Wi-Fi MAC, baseband and direct-conversion radio with integrated PA, LNA and transmit/receive switch removing the need for an RF front-end module (FEM) saving cost and reducing system complexity.

In addition to a Wi-Fi 5 radio, the IW512 integrates an independent Bluetooth 5.4 and 802.15.4 subsystem that supports Thread mesh networks. The device features Bluetooth Profiles such as hands free (HFP), advanced audio distribution profile (A2DP) for audio streaming as well as additional profiles like dual wideband speech (WBS). For Bluetooth Low Energy, the IW512 enables 2 Mbit/s high-speed data rate, long range, and extended advertising. Finally, LE Audio is supported using Isochronous channels for a better overall audio experience.

The IW512 integrates dedicated CPUs and memories for both the Wi-Fi and Bluetooth/802.15.4 subsystems, which enable real time, independent protocol processing. Interfaces for connecting the IW512 to external host processors include SDIO 3.0 for Wi-Fi, UART for Bluetooth and SPI for 802.15.4.

IW512 internal block diagram Block Diagram

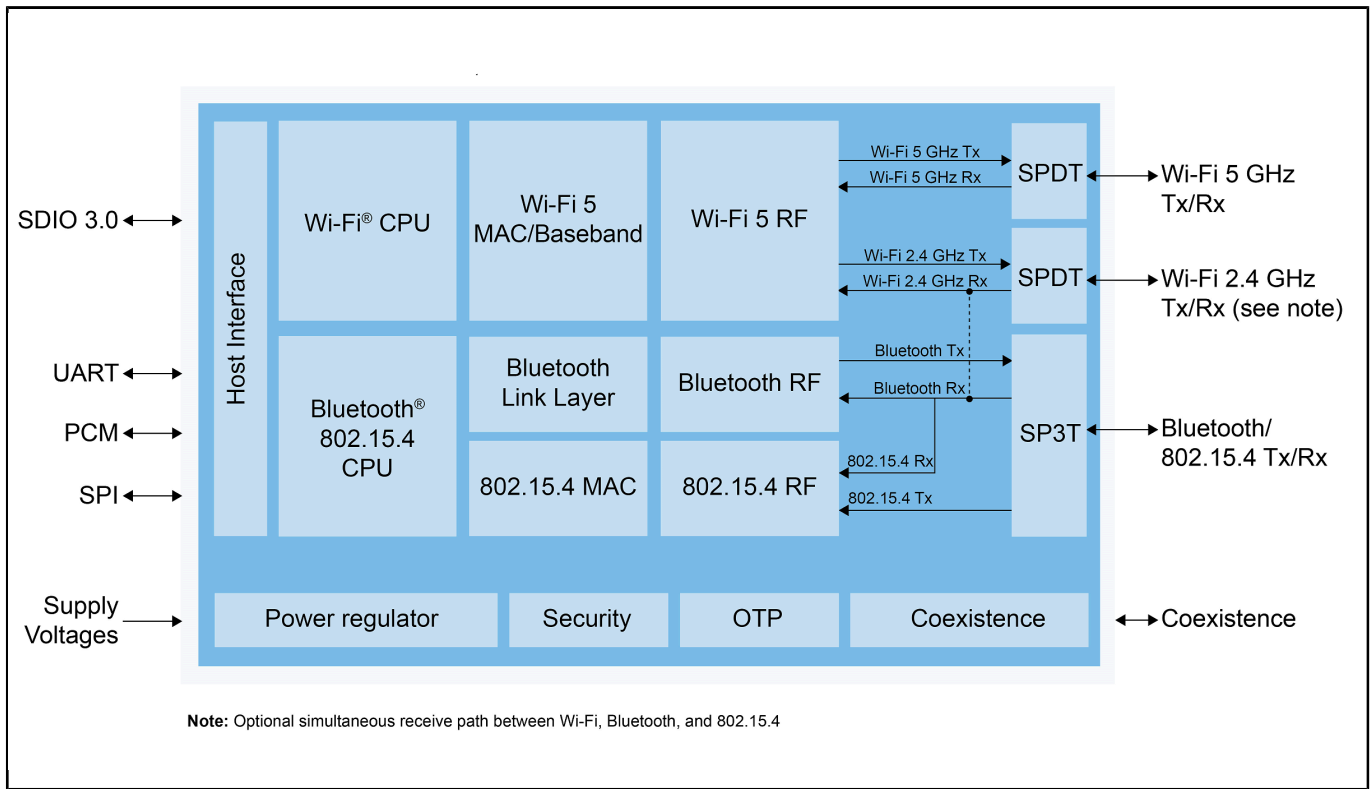

IW512 application diagram - Single antenna Block Diagram

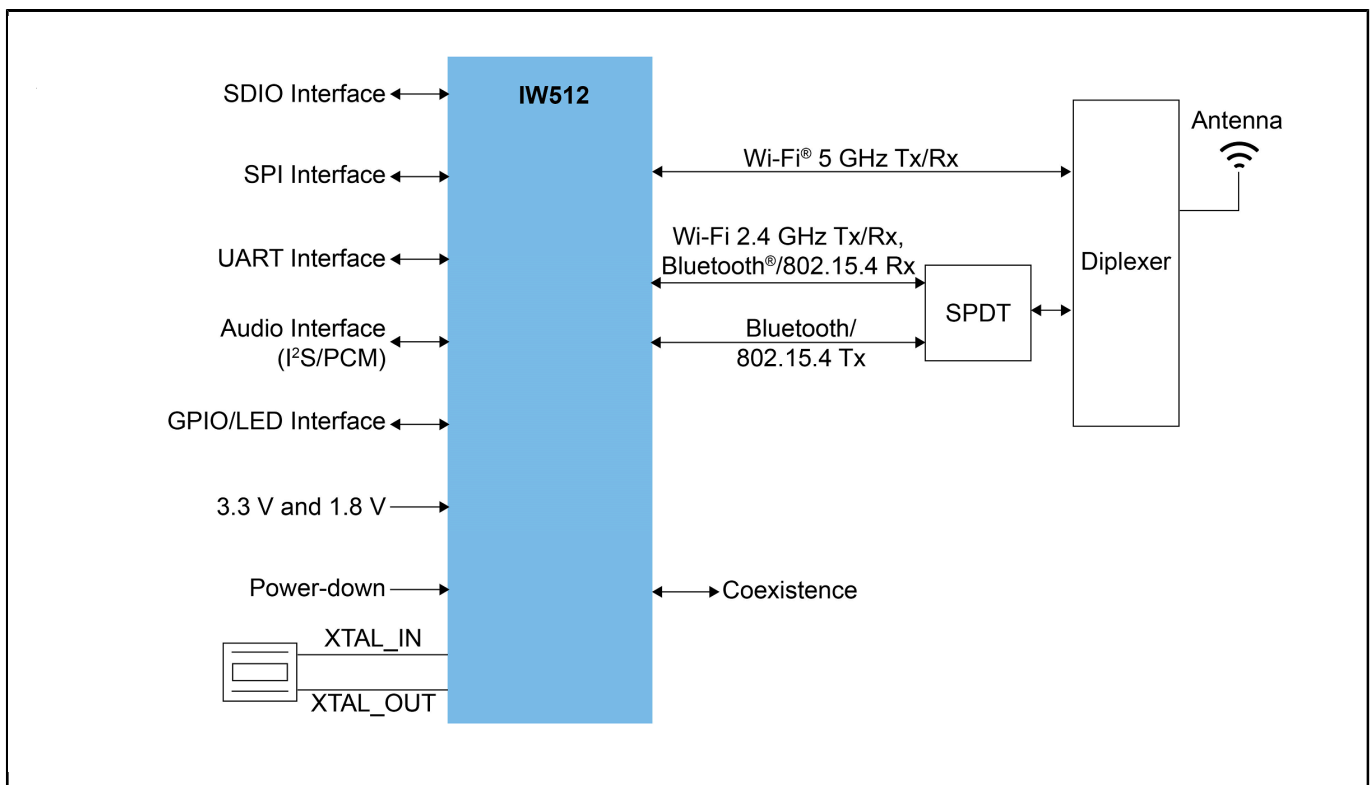

IW512 application diagram - Dual antenna Block Diagram

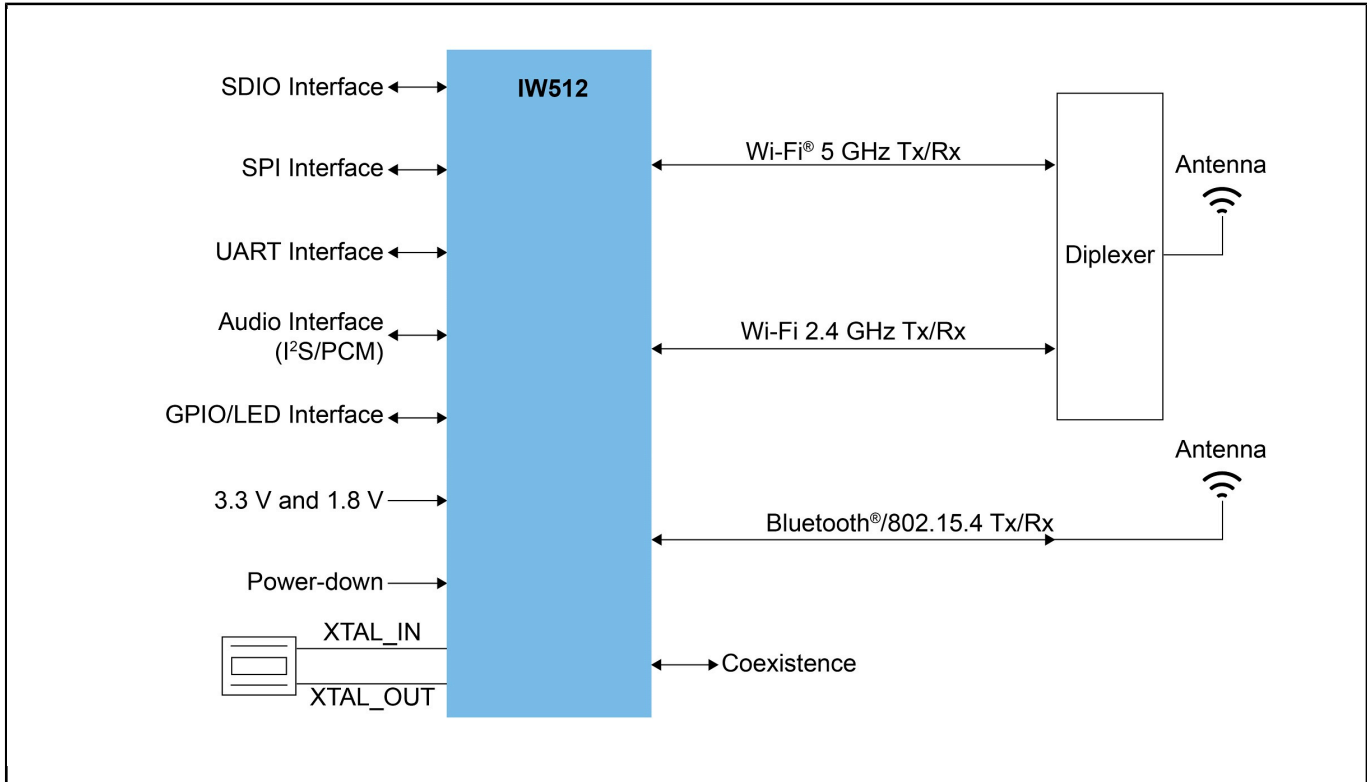

View additional information for [2.4/5 GHz Dual-Band 1x1 Wi-Fi® 5 \(802.11ac\) + Bluetooth® 5.4 + 802.15.4 Tri-radio Solution](#).

Note: The information on this document is subject to change without notice.

www.nxp.com

NXP and the NXP logo are trademarks of NXP B.V. All other product or service names are the property of their respective owners. The related technology may be protected by any or all of patents, copyrights, designs and trade secrets. All rights reserved. © 2025 NXP B.V.