

AN11155

General design guidelines for the NXP capacitive sensors

Rev. 2 — 14 March 2014

Application note

Document information

Info	Content
Keywords	Design, Guidelines, PCF8885, PCA8885
Abstract	This document describes design aspects which should be considered for application circuits using NXP capacitive sensors.



Revision history

Rev	Date	Description
v.2	20140314	revised version
v.1	20120203	new application note, first revision

Contact information

For more information, please visit: <http://www.nxp.com>

For sales office addresses, please send an email to: salesaddresses@nxp.com

1. Introduction

In order to obtain proper function when using touch sensors, certain design guidelines must be followed for the application circuit and the design of sensor plates.

This application note considers the typical application circuit on a pin-by-pin basis and recommends appropriate components.

A theoretical background for the design of sensor plates is given and applies also on sliders and key matrices.

2. Typical application circuit

[Figure 1](#) illustrates the application circuit for PCF8885. A cascaded solution may be implemented easily by following the data sheets [Ref. 4 “PCA8885”](#) and [Ref. 5 “PCF8885”](#). Pin description is found in [Table 1](#). It also contains some remarks in addition to the data sheets.

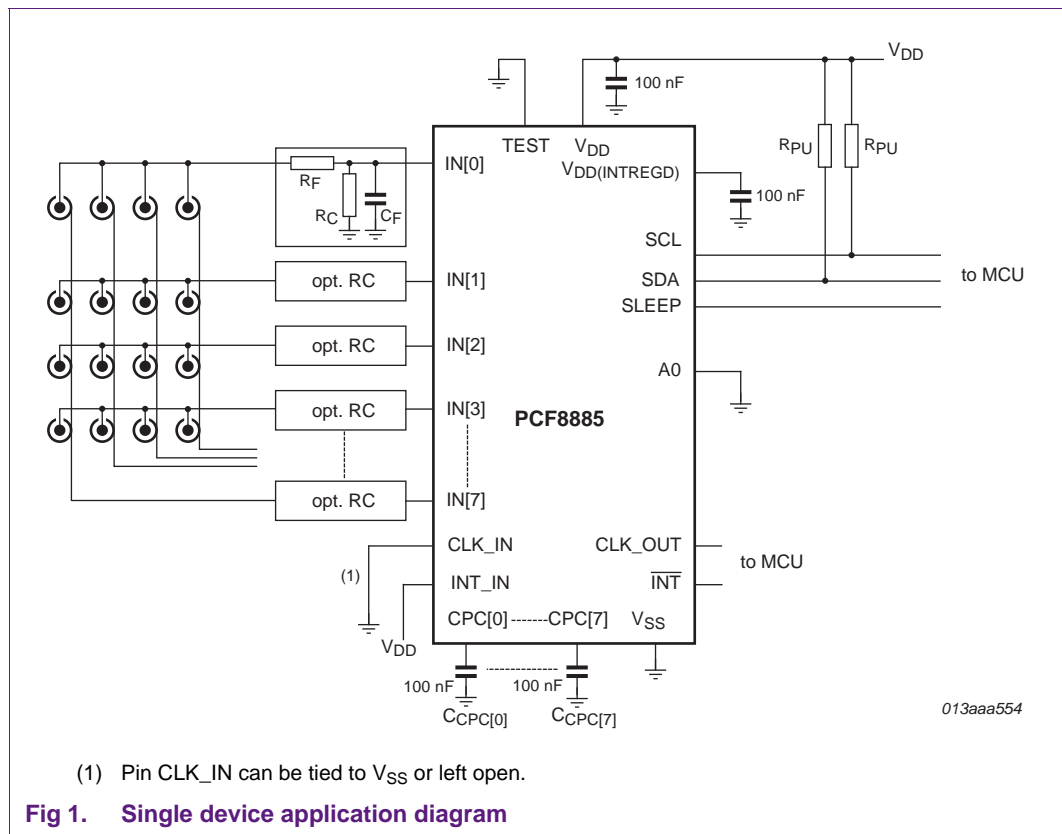

Table 1. Additional information on the pins of the PCx8885

Symbol	Pin	Type	Description
CLK_OUT	1	output	clock output for chip cascading and synchronization; if not used: this output should be disabled in register CLKREG; it is recommended to be decoupled with 100 nF for highest immunity but can be floating in less noisy environments
V _{DD} (INTREGD)	2	supply	internal regulated supply reference voltage; this pin must be decoupled with a 100 nF capacitor also when not used
IN	3 to 10	analog input/output	sensor input, channel 0 to 7; for higher RF noise immunity, the low-pass filter described in Ref. 3 "AN11157" (EMC) may be implemented; for higher ESD level, the 8-ch PRTR5V0U8S described in Ref. 3 "AN11157" (EMC) will provide protection up to 8 kV; the input capacitance range of the PCx8885 is 10 pF to 40 pF. In the case that the parasitic capacitance of the sensor pads and the routing is lower than 10 pF, 10 pF capacitors have to be used in parallel with the inputs
CPC	11 to 18	analog input/output	reservoir capacitor, channel 0 to 7; these capacitors should be low leakage X7R or C0G capacitors with insulation resistance larger than 5 GΩ
V _{SS}	19	supply	ground supply voltage
SCL	20	input	I ² C serial clock line
SDA	21	input/output	I ² C serial data line
TEST	22	input	test pin; must be connected to V _{SS}
A0	23	input	I ² C subaddress
SLEEP	24	input	sleep mode; connect to V _{DD} to force the circuit into low-power sleep mode; if not used, this pin should be decoupled with a 100 nF capacitor
INT	25	output	interrupt output; if not used, it should be disabled with the clear-int command and decoupled with 100 nF for highest immunity

Table 1. Additional information on the pins of the PCx8885 ...continued

Symbol	Pin	Type	Description
V _{DD}	26	supply	supply voltage
INT_IN	27	input	interrupt input for chip cascading; connect to V _{DD} if not used
CLK_IN	28	input	clock input; for the secondary chip when the primary chip provides the clock signal; if not used, it should be configured accordingly and decoupled with 100 nF for higher noise immunity

2.1 Sensitivity - design considerations

In order to design sensor plates for highest sensitivity, some NXP touch sensor specific features and general understanding of electrical fields as well as capacitive coupling have to be recalled.

2.1.1 Steady state capacitance

One of the major differences between the NXP touch sensors and competitive parts in the market is, that NXP sensors react on certain changes in capacitance instead of measuring absolute capacitance. Providing the capacitive load is in the specified range of 10 pF to 40 pF, any capacitance change at the speed of a typical moving finger will be detected.

Remark: The steady state capacitance originating from the layout, slowly changing environmental conditions, accumulating dirt, and so on, will be compensated for by the auto-calibration mechanism.

2.1.2 Approach sensitivity

The definition of normal approach speed is application-dependent. The approach to touch buttons on a control panel is much slower than to key pads, wheel-switches or sliders.

In the default settings, the oscillator frequency is 70 kHz. The clock frequency derived from the oscillator with the default divisor is: $70 \text{ kHz} / 16 = 4.4 \text{ kHz}$. As the sensor input channels are sampled sequentially, it will result in $4.4 \text{ kHz} / 8 = 0.55 \text{ kHz}$ sampling frequency.

To define a capacitive event, 64 consecutive samples are required. With a sampling frequency of 0.55 kHz, it will take 117 ms. The lower the frequency, the longer is the switching time. The sampling frequency may be set to higher values to detect quick movements, for instance for a keypad.

Remark: The approach sensitivity can be adjusted for every application with two configuration commands. With $m = 1$ being the default value, the oscillator frequency (f_{osc}) can be tuned in the range $0.5 < m < 1.75$ in eight steps.

The clock frequency can be derived from $f_{osc}/n = f_{clk}$ where $n = 1, 4, 16, \text{ or } 64$. The switching time vs. sampling frequency is shown in [Figure 2](#).

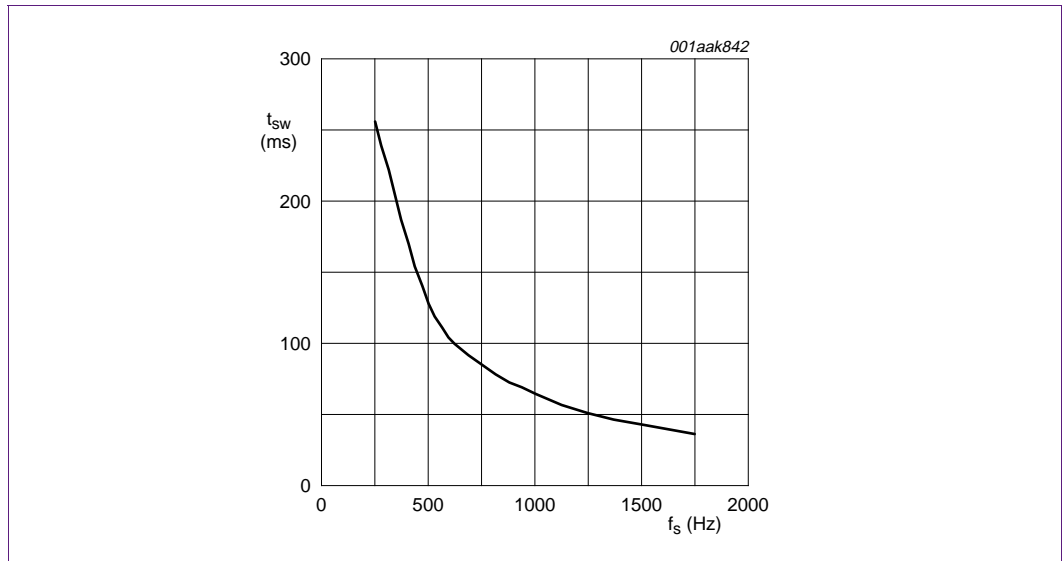

Fig 2. Switching time (t_{sw}) with respect to sampling frequency (f_s)

A typical human touch in push-button applications has approximately the course shown in [Figure 3](#). A sampling frequency about 1 kHz is recommended as a start value for optimizing the approach sensitivity.

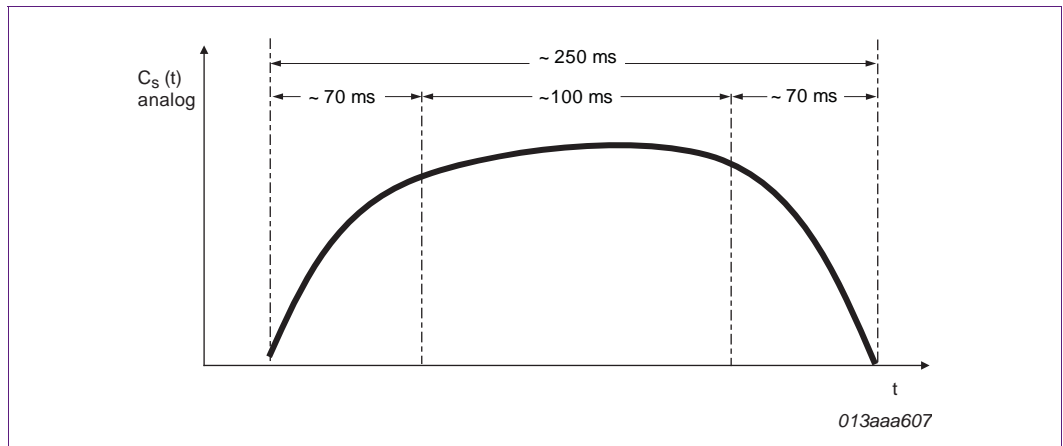

Fig 3. Typical human touch on push button

2.2 Unused sensor channels

In case, a sensor channel is not used, the sensor input pin has to be left floating and the corresponding CPCx capacitor pin must be tied to GND. The corresponding bit in the MASK register must be logic 0 and the MSKMODE bit in the CONFIG register has to be logic 1 to permanently mask a channel.

If the MSKMODE cannot be set logic 1 for whatever reason, there will be sampling pulses even on the masked-out channels. Then the CPC pins have to be left open or even better decoupled with a few nF. Otherwise the channels remain in fast-start mode and the overall current consumption is far above the normal idle current.

3. Design of sensor plates

The steady state capacitance between the sensor plates, traces, and GND is compensated for by the auto-calibration mechanism. Therefore the primary condition to consider for design of sensor plates is to maximize the capacitance between the approaching finger and the sensor plate. Likewise the capacitance between the finger and any GND has to be minimized.

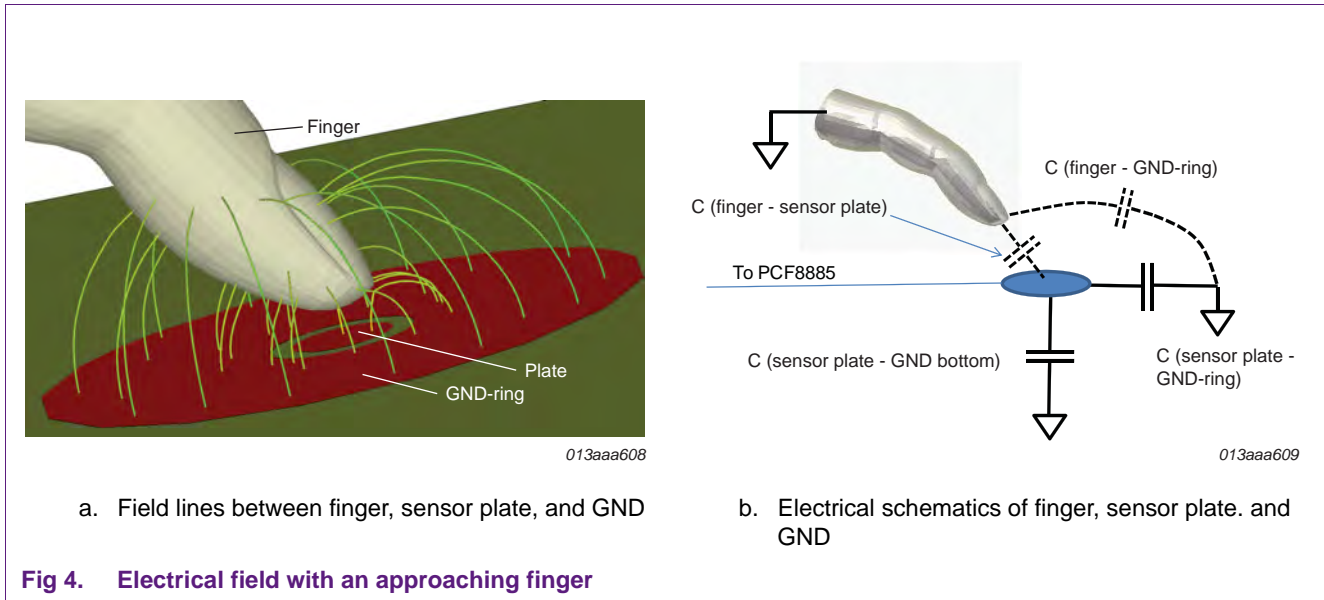

Fig 4. Electrical field with an approaching finger

In order to provide the basics behind layout considerations, the simple round sensor plate in [Figure 4](#) is studied with CST EM Studio, a simulation tool from Computer Simulation Technology. The sensor plate is realized on a 1.5 mm thick PCB with solid GND on the rear side and the sensor plate is surrounded by solid GND. The diameter of the sensor plate is 10 mm, the gap to GND-ring is 2.2 mm and the overlay acrylic is 3 mm thick.

From the model and electrostatic simulation, it is apparent that there will be a significant stray capacitance between the finger and the GND-ring besides the intentional capacitance between the finger and the sensor plate. [Table 2](#) shows that the capacitance between an approaching finger and any GND nearby the sensor plate will be higher than between the finger and the sensor plate. This highlights the need of minimized stray capacitance between an approaching finger and conductors nearby. In the capacitance table ([Table 2](#)), the elements between different conductors indicate the mutual capacitance between those conductors.

Table 2. Capacitance between finger, sensor plate, and GND

Finger to Plate	Finger to GND-ring	Plate to GND-ring	Plate to GND-bottom	Unit
0.5	1.2	0.7	3.8	pF

In the following sections, the parts of a sensor plate layout are studied in detail.

3.1 Overlay

The overlay between the finger and the sensor plate should be kept as thin as possible. Higher relative permittivity of the material will increase the sensitivity. To understand this, the simple parallel plate capacitance expression can be studied.

$C = (\epsilon A)/d$, where the dielectric constant ϵ is a product of the free space permittivity (ϵ_0) and the relative permittivity (ϵ_r) of the media. 'A' is the area of the plates and 'd' is the thickness of the insulation media. [Table 3](#) shows some materials and their relative permittivity for reference.

Table 3. Relative permittivity of some overlay materials

Material	Relative permittivity (ϵ_r)
Air	1
FR-4	4.7
Glass	5 to 10
Acrylic	3
Water	80

3.2 GND-ring

GND-ring around sensor plates will increase noise immunity but decrease the sensitivity due to the finger-to-GND stray capacitance. So what is the optimal separation? A rule of thumb is that the separation should be greater than the overlay thickness. However having 5 mm separation for 5 mm overlay would result in a total sensor plate and GND-ring of more than 20 mm in diameter which would be difficult to implement due to space constraints.

Electrostatic simulations show that the major decrease of stray capacitance obtained once the sensor plate-to-GND separation is over 2 mm.

[Figure 5](#) illustrates the mutual capacitance between a touching finger, sensor plate, and the GND-ring as function of the separation. The overlay is 3 mm thick acrylic.

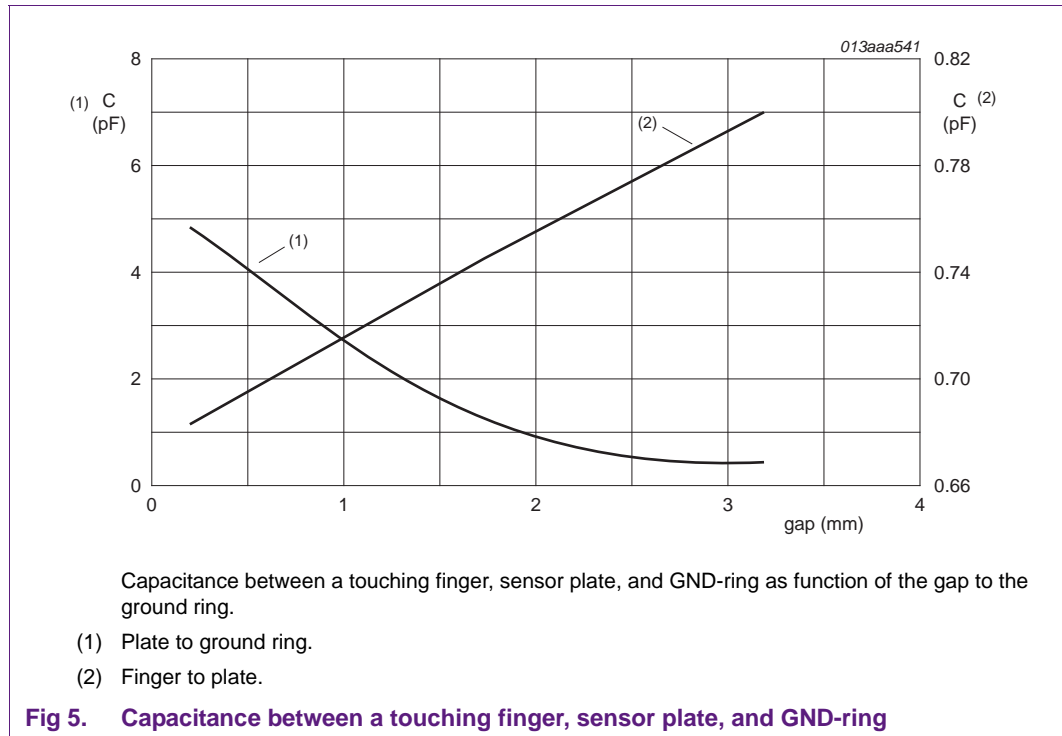

3.3 Sensor plate

The sensor plate size is per definition a major element in the sensitivity as it is defining the size of the parallel plate capacitor and the touching finger.

The ideal sensor plate diameter for a normal sized finger is about 11 mm allowing an overlay thickness of 3 mm and GND separation of approx. 2 mm.

The relation between the sensor plate diameter and the overlay thickness should be about $\text{sensor plate diameter} = \text{overlay thickness} + 8 \text{ mm}$.

Round-shaped sensor plates will have a maximized sensing area and are recommended.

3.4 Air gaps and extensions

The overlay material should ideally be stiff and the capacitive event should be defined by touching the overlay and not deforming it. The consequence of the latter case would be a capacitance change for neighboring buttons and therefore false switching.

Likewise, air gaps between overlay and the sensor plates should be avoided to get a well-defined structure.

As a matter of fact, in many applications the overlay is not directly put on the PCB and the sensor plate is physically extended with a conductive material. The advantage of this implementation is that the stray capacitance to surrounding GND conductors is reduced but the disadvantage is that the noise immunity is reduced as well.

[Figure 6](#) illustrates how the sensor electrode is extended to avoid air gaps and allow relaxed front panel design.

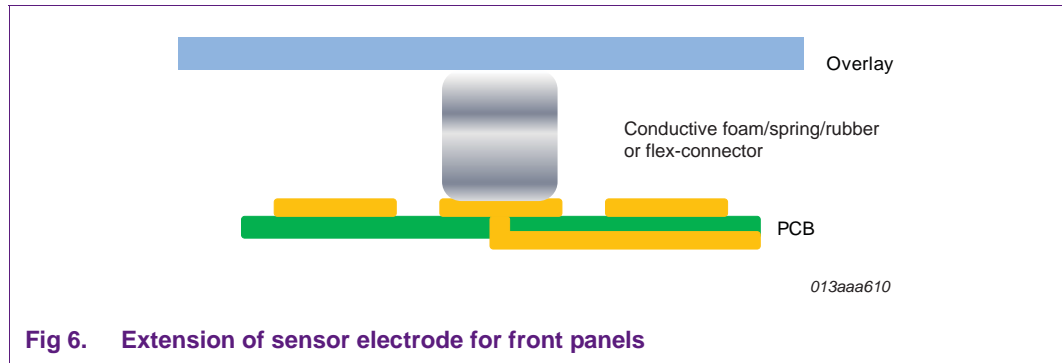

3.5 Profiled overlay for higher sensitivity

In applications where the sensor plates are densely placed and high noise immunity is desired, the GND separation might be reduced down to 0.2 mm. In order to reduce the negative impact of the GND on the sensitivity, the overlay may be profiled as illustrated in [Figure 7](#). The air gap over the GND will reduce the stray capacitance while the finger-to-sensor plate capacitance is preserved.

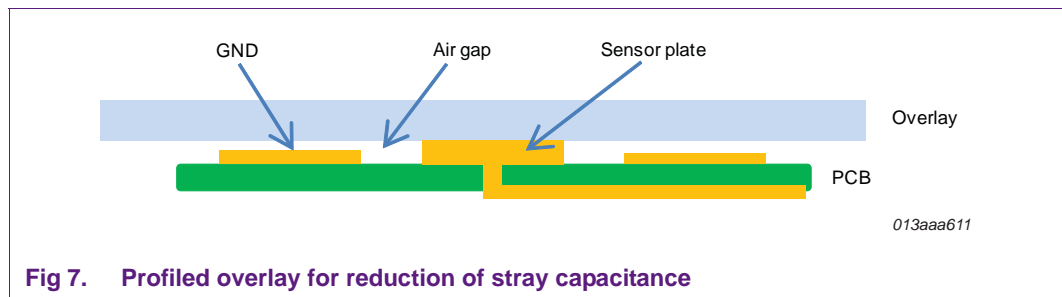

3.6 Flexible substrates

In most applications, the front panel is not a flat plastic cover but rather a rounded or a bent shape. For such cases, it is beneficial to use a flexible single-sided substrate. Thanks to small thickness of such substrates and high relative permittivity, the substrate can be attached to the front panel efficiently with double-sided adhesive films or other means available.

The advantage of such a solution is that the component and sensor plate side of the substrate can be inside the instrument and the electrical field propagates through the flexible substrate and the hard instrument cover without any significant attenuation.

As shown in [Figure 8](#), flexible substrates can efficiently be used to realize advanced mechanical shapes as well as openings for illumination.

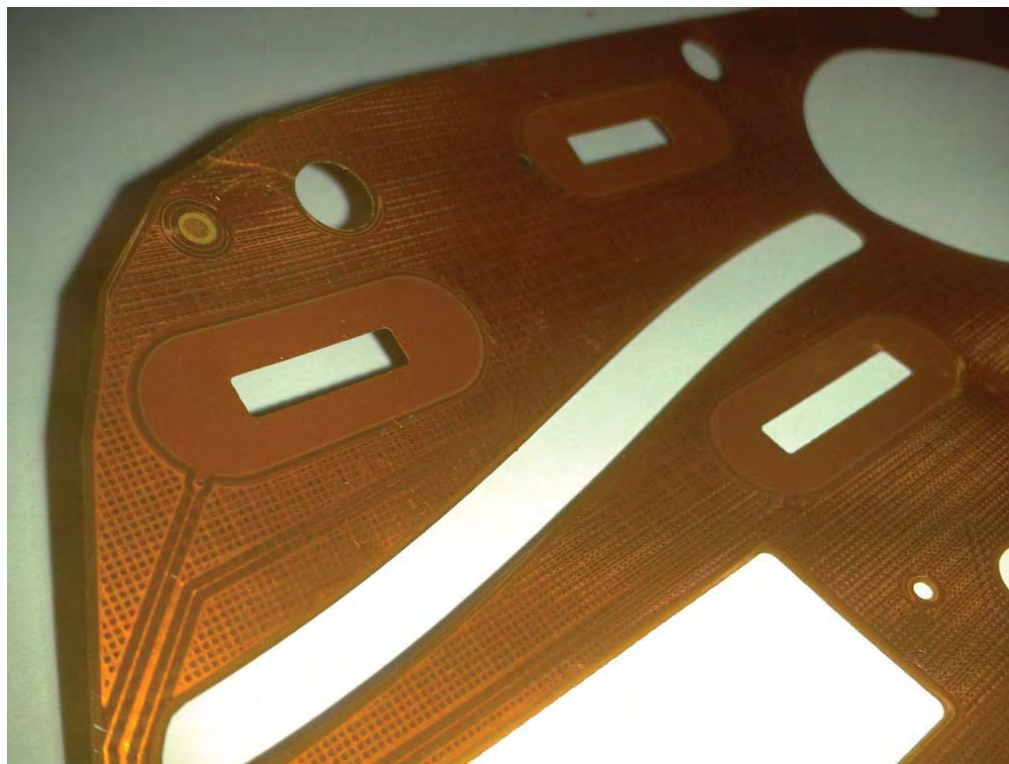

013aaa612

Fig 8. Sensor plates on flexible substrates

4. References

- [1] **AN10832** — PCF8883 - capacitive proximity switch with auto-calibration
- [2] **AN11122** — Water and condensation safe touch sensing with the NXP capacitive touch sensors, Application Note
- [3] **AN11157** — Capacitive touch sensing with high EMC performance, Application Note
- [4] **PCA8885** — Capacitive 8-channel proximity switch with auto-calibration and very low-power consumption, Data Sheet
- [5] **PCF8885** — Capacitive 8-channel proximity switch with auto-calibration and very low-power consumption, Data Sheet

5. Legal information

5.1 Definitions

Draft — The document is a draft version only. The content is still under internal review and subject to formal approval, which may result in modifications or additions. NXP Semiconductors does not give any representations or warranties as to the accuracy or completeness of information included herein and shall have no liability for the consequences of use of such information.

5.2 Disclaimers

Limited warranty and liability — Information in this document is believed to be accurate and reliable. However, NXP Semiconductors does not give any representations or warranties, expressed or implied, as to the accuracy or completeness of such information and shall have no liability for the consequences of use of such information. NXP Semiconductors takes no responsibility for the content in this document if provided by an information source outside of NXP Semiconductors.

In no event shall NXP Semiconductors be liable for any indirect, incidental, punitive, special or consequential damages (including - without limitation - lost profits, lost savings, business interruption, costs related to the removal or replacement of any products or rework charges) whether or not such damages are based on tort (including negligence), warranty, breach of contract or any other legal theory.

Notwithstanding any damages that customer might incur for any reason whatsoever, NXP Semiconductors' aggregate and cumulative liability towards customer for the products described herein shall be limited in accordance with the *Terms and conditions of commercial sale* of NXP Semiconductors.

Right to make changes — NXP Semiconductors reserves the right to make changes to information published in this document, including without limitation specifications and product descriptions, at any time and without notice. This document supersedes and replaces all information supplied prior to the publication hereof.

Suitability for use — NXP Semiconductors products are not designed, authorized or warranted to be suitable for use in life support, life-critical or safety-critical systems or equipment, nor in applications where failure or malfunction of an NXP Semiconductors product can reasonably be expected to result in personal injury, death or severe property or environmental damage. NXP Semiconductors and its suppliers accept no liability for inclusion and/or use of NXP Semiconductors products in such equipment or applications and therefore such inclusion and/or use is at the customer's own risk.

Applications — Applications that are described herein for any of these products are for illustrative purposes only. NXP Semiconductors makes no representation or warranty that such applications will be suitable for the specified use without further testing or modification.

Customers are responsible for the design and operation of their applications and products using NXP Semiconductors products, and NXP Semiconductors accepts no liability for any assistance with applications or customer product design. It is customer's sole responsibility to determine whether the NXP Semiconductors product is suitable and fit for the customer's applications and products planned, as well as for the planned application and use of

customer's third party customer(s). Customers should provide appropriate design and operating safeguards to minimize the risks associated with their applications and products.

NXP Semiconductors does not accept any liability related to any default, damage, costs or problem which is based on any weakness or default in the customer's applications or products, or the application or use by customer's third party customer(s). Customer is responsible for doing all necessary testing for the customer's applications and products using NXP Semiconductors products in order to avoid a default of the applications and the products or of the application or use by customer's third party customer(s). NXP does not accept any liability in this respect.

Export control — This document as well as the item(s) described herein may be subject to export control regulations. Export might require a prior authorization from competent authorities.

Evaluation products — This product is provided on an "as is" and "with all faults" basis for evaluation purposes only. NXP Semiconductors, its affiliates and their suppliers expressly disclaim all warranties, whether express, implied or statutory, including but not limited to the implied warranties of non-infringement, merchantability and fitness for a particular purpose. The entire risk as to the quality, or arising out of the use or performance, of this product remains with customer.

In no event shall NXP Semiconductors, its affiliates or their suppliers be liable to customer for any special, indirect, consequential, punitive or incidental damages (including without limitation damages for loss of business, business interruption, loss of use, loss of data or information, and the like) arising out of the use of or inability to use the product, whether or not based on tort (including negligence), strict liability, breach of contract, breach of warranty or any other theory, even if advised of the possibility of such damages.

Notwithstanding any damages that customer might incur for any reason whatsoever (including without limitation, all damages referenced above and all direct or general damages), the entire liability of NXP Semiconductors, its affiliates and their suppliers and customer's exclusive remedy for all of the foregoing shall be limited to actual damages incurred by customer based on reasonable reliance up to the greater of the amount actually paid by customer for the product or five dollars (US\$5.00). The foregoing limitations, exclusions and disclaimers shall apply to the maximum extent permitted by applicable law, even if any remedy fails of its essential purpose.

Translations — A non-English (translated) version of a document is for reference only. The English version shall prevail in case of any discrepancy between the translated and English versions.

5.3 Licenses

ICs with capacitive sensing functionality

This NXP Semiconductors IC is made under license to European Patent No. 0723339, owned by EDISEN - SENSOR SYSTEME GmbH & CO KG and counterparts. Any license fee is included in the purchase price.

5.4 Trademarks

Notice: All referenced brands, product names, service names and trademarks are the property of their respective owners.

6. Tables

Table 1.	Additional information on the pins of the PCx8885	4
Table 2.	Capacitance between finger, sensor plate, and GND	7
Table 3.	Relative permittivity of some overlay materials.	8

7. Figures

- Fig 1. Single device application diagram3
- Fig 2. Switching time (t_{sw}) with respect to sampling frequency (f_s)6
- Fig 3. Typical human touch on push button6
- Fig 4. Electrical field with an approaching finger7
- Fig 5. Capacitance between a touching finger, sensor plate, and GND-ring.9
- Fig 6. Extension of sensor electrode for front panels. . .10
- Fig 7. Profiled overlay for reduction of stray capacitance10
- Fig 8. Sensor plates on flexible substrates11

8. Contents

1	Introduction	3
2	Typical application circuit	3
2.1	Sensitivity - design considerations	5
2.1.1	Steady state capacitance	5
2.1.2	Approach sensitivity	5
2.2	Unused sensor channels	6
3	Design of sensor plates	7
3.1	Overlay	8
3.2	GND-ring	8
3.3	Sensor plate	9
3.4	Air gaps and extensions	9
3.5	Profiled overlay for higher sensitivity	10
3.6	Flexible substrates	10
4	References	11
5	Legal information	12
5.1	Definitions	12
5.2	Disclaimers	12
5.3	Licenses	12
5.4	Trademarks	12
6	Tables	13
7	Figures	14
8	Contents	15

Please be aware that important notices concerning this document and the product(s) described herein, have been included in section 'Legal information'.

© NXP Semiconductors N.V. 2014.

All rights reserved.

For more information, please visit: <http://www.nxp.com>

For sales office addresses, please send an email to: salesaddresses@nxp.com

Date of release: 14 March 2014

Document identifier: AN11155