

Vehicle Service-oriented Gateway Opportunities and Enablement

Brian Carlson

Director, Product Line Management
Automotive Microcontrollers & Processors – Connectivity & Security

June 2019 | Session #AMF-AUT-T3621



SECURE CONNECTIONS
FOR A SMARTER WORLD

Agenda

- Market Opportunities
- Introduction to the Service-oriented Gateway
- NXP MPC-LS Chipset Solution and Enablement
- Unlocking Value of Connected Vehicle Data
- Related Presentations/Demo @ NXP Connects



CONNECTED VEHICLES

38
MILLION

Shipped in 2018*

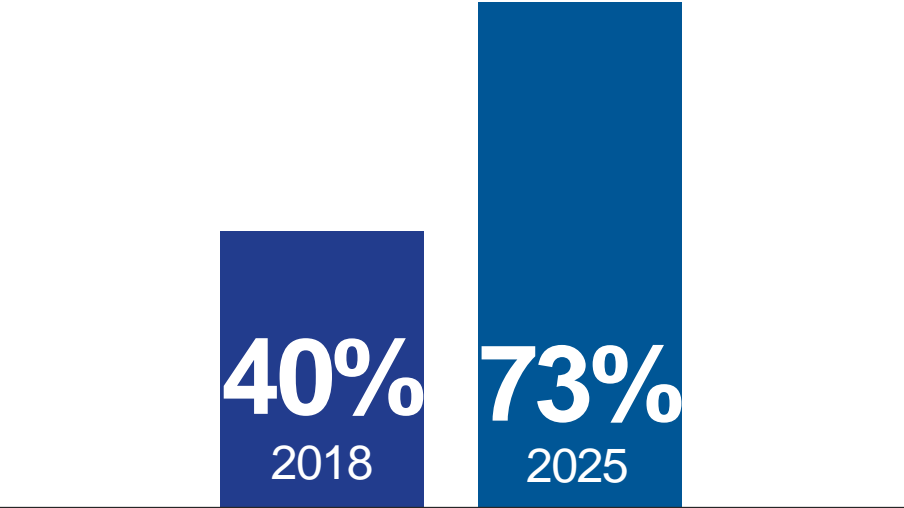

Connected vehicle penetration*

VEHICLE DATA

4+
TERABYTES

Vehicle data generated per hour**

Represents global data
Sources: *Strategy Analytics, 2019; **ABI Research, 2018



Vehicle Data Opportunities Will Transform the Automotive Industry

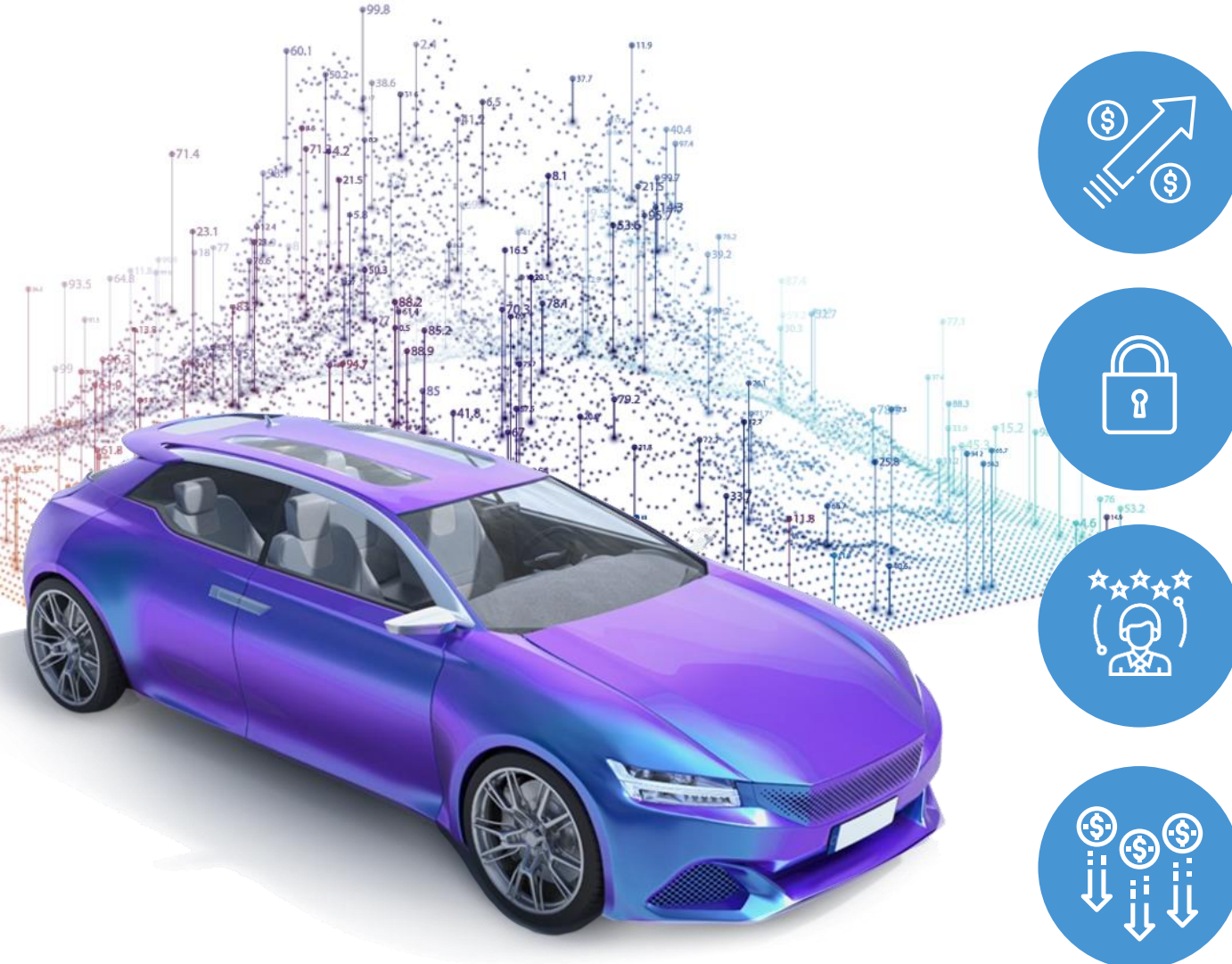

New Revenue Streams

Up to \$750B* for data-driven services by 2030
77.4% millennials** willing to pay for updates



Enhanced Safety and Security

Fault detection & notification
Intrusion detection and prevention
Crash detection / emergency response



Improved User Experiences

Personalization, comfort and convenience
Post-sale feature upgrades
Location-based services

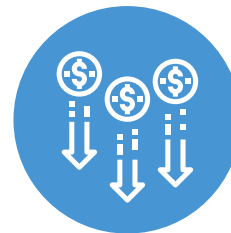

Reduced Costs

Predictive maintenance
Reduced warranty / recall exposure
Fleet management

Gateway

Over-the-Air Updates
Vehicle Services

The gateway has central access to vehicle data which can enable new services and opportunities

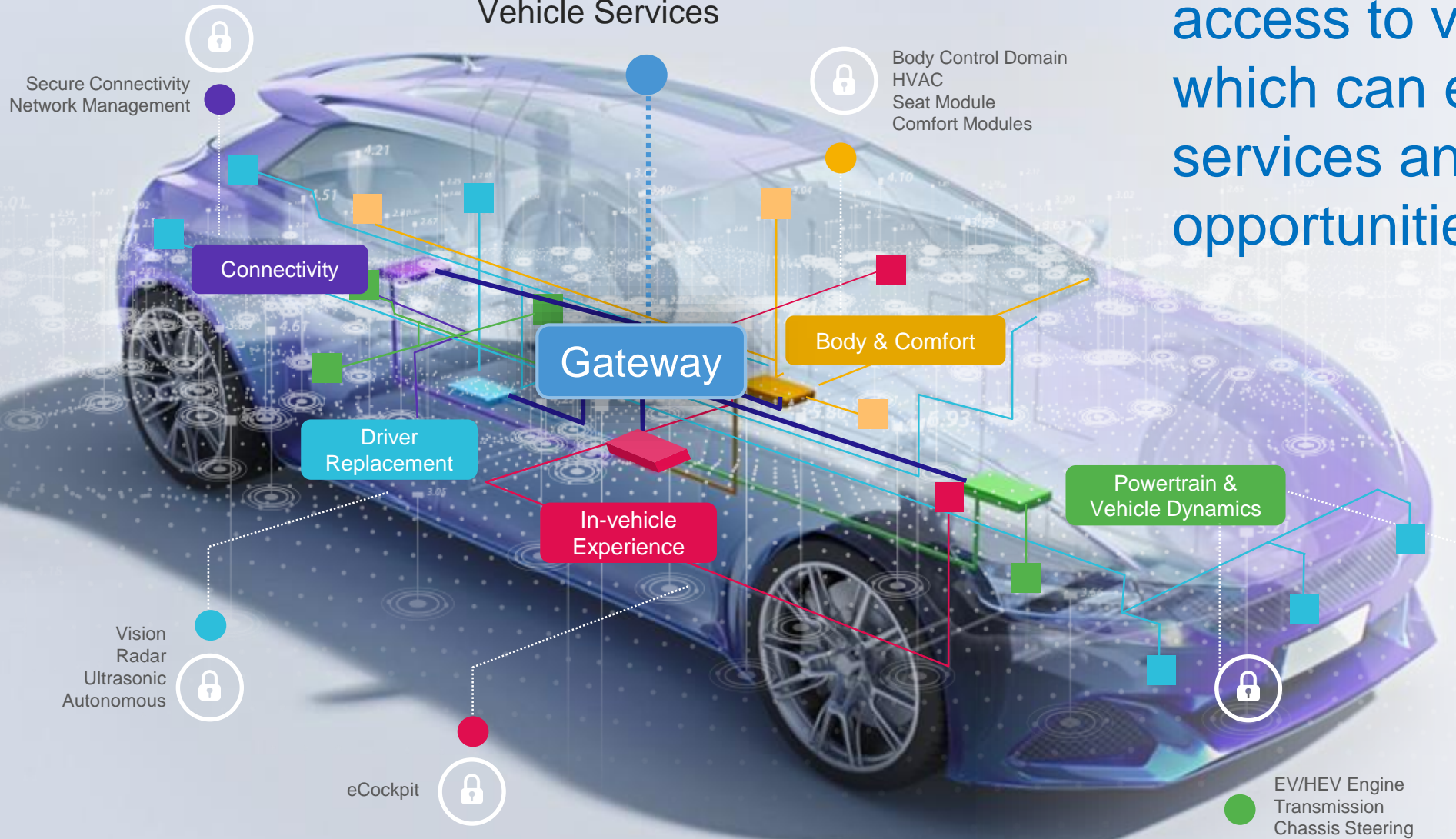

Automotive Gateway is Central for Vehicle Communications

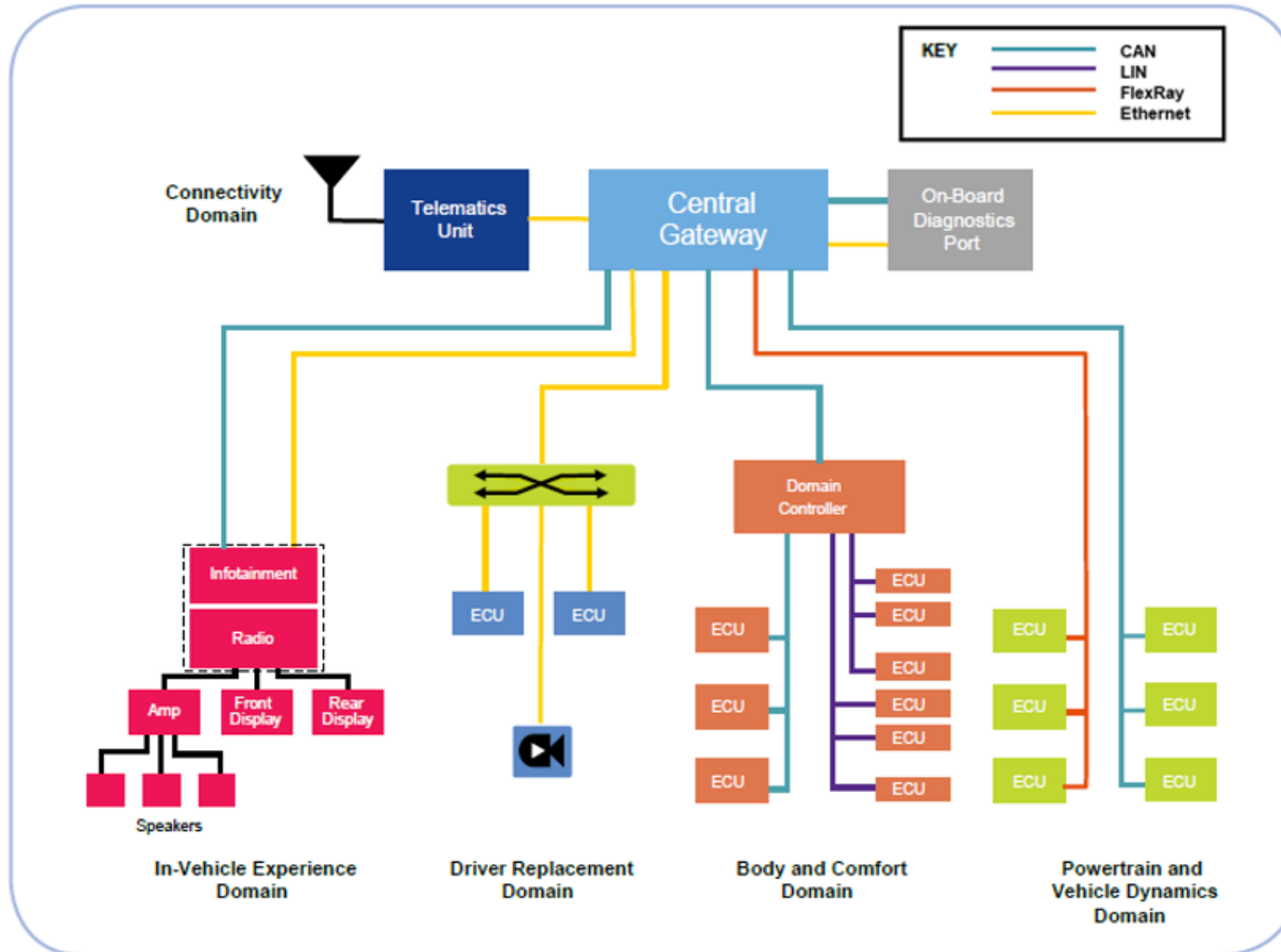

Gateway Rise and Evolution

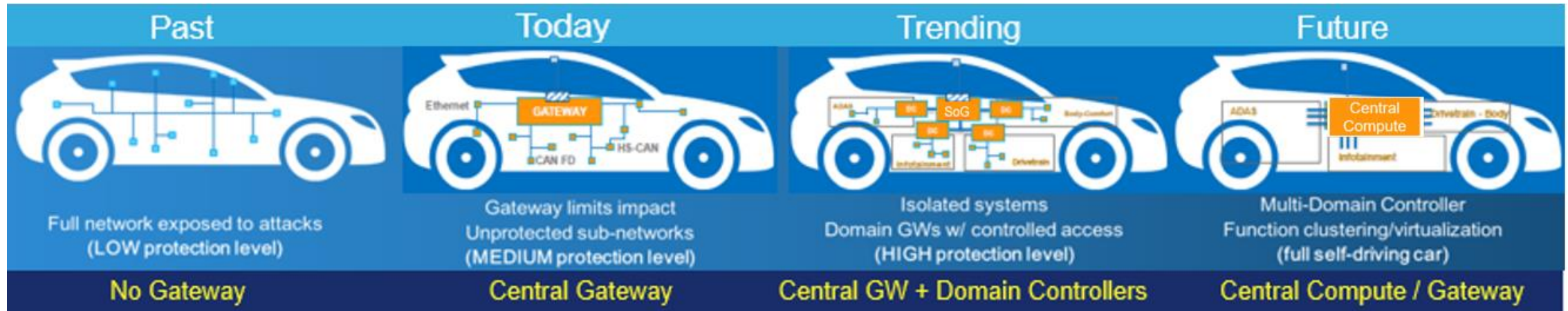

- No or limited connectivity



- High-speed wireless interfaces (4G→5G, Wi-Fi)

- No or limited security



- High security, isolation, public key crypto, contextual firewall, intrusion detection

- Basic routing



- Advanced routing, vehicle OTA, analytics, ECU consolidation, new services

- Limited bandwidth / scalability
(kilobit / Megabit interfaces)



- High-bandwidth, scalable architectures
(Gigabit interfaces)

Gateways are evolving into “Service-oriented Gateways”

Key Gateway Use Cases

- The Gateway is becoming the central, critical component in vehicle architectures
 - System security, OTA management, applications/services, analytics, vehicle compute, and more
- Gateways are shifting to software-centric solutions → introducing new services
 - Enables OEM differentiation, operational efficiency, and new revenue generation
 - Improves customer satisfaction
- Protocol and Data Translation
 - Network protocol-to-protocol translation
 - Raw data-to-contextual information
- Network Security
 - High-performance contextual firewall
 - Intrusion Detection and Prevention System
 - Authentication and Secure Messages
 - Network Key Management
- Over-the-Air (OTA) Updates Management
 - Remote upgrades (new features, safety/security patches...)
- Apps Processing / Services
 - ECU consolidation
 - Analytics (edge processing and edge-to-cloud)
 - Remote monitoring and condition-based maintenance (prognostics / vehicle health monitoring)
 - Centralized functions (vehicle identity, power strategy...)
 - Agile deployment of future functionality

Service-oriented Gateway Services

Vehicle-wide Over-the-Air (OTA) Updates

Deployment of remote apps, machine learning models, security and safety patches...

Edge-to-Cloud Data Analytics

Edge processing of vehicle data, pre-processing for cloud analysis and machine-learning models

Virtual ECUs

Consolidation of vehicle ECUs to reduce system cost, weight, cable harness complexity

Intrusion Detection and Prevention

Real-time vehicle network security monitoring and updates for protection against new cyber threats

Data Logging and Forensics

Centralized “black box” capability for analysis, including filtering and pre-processing of vehicle data

Centralized Vehicle Security

Remote key provisioning, secure key management, cryptographic functions and secure OTA and services

Many more services to come...

Provides platform for services innovation and supports new initiatives like Mobility-as-a-Service (MaaS)

Gateway to Service-oriented Gateway Evolution

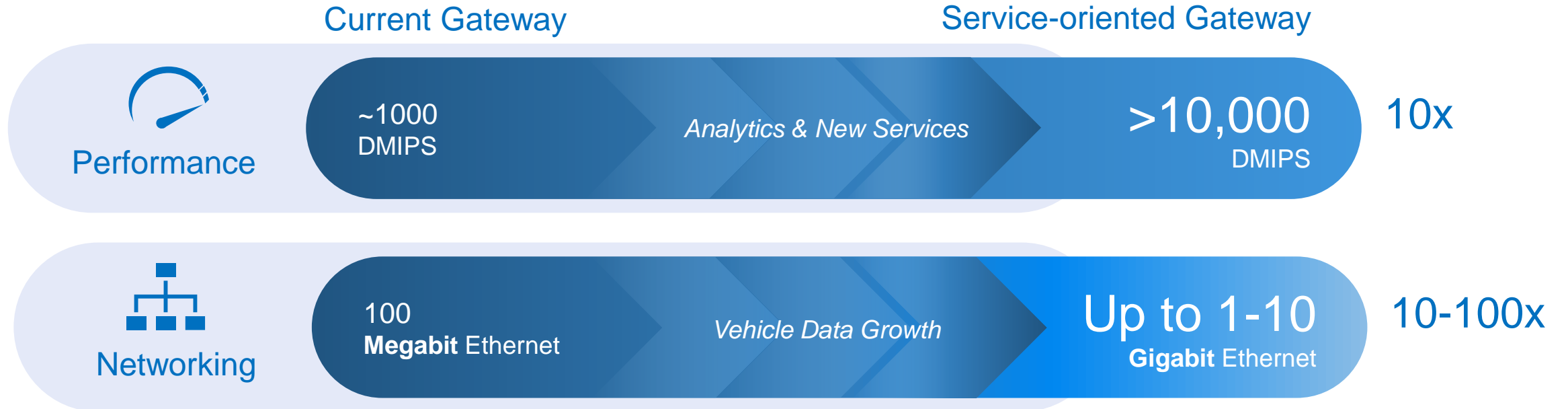

Service-oriented gateways require ~10x performance and networking

Learning from Mobile Market Product Evolution



Cellphone

Communications → Applications & Services
kbps → Gbps Data Rates
Massive Increase in Processor Performance
Over-the-Air Updates
Enhanced Security



Smartphone



Evolution of Products



Gateway

Higher-speed Connectivity +
Applications/Services + OTA Updates
=

Growth and New Opportunities



Service-oriented
Gateway

MPC-LS VEHICLE NETWORK PROCESSING CHIPSET

MPC-LS Vehicle Network Processing Chipset for Service-oriented Gateways

Heterogenous multi-core processing

- Real-time + high-performance applications

Automotive meets enterprise networking

- CAN FD, LIN, FlexRay™ interfaces
- Up to 10 Gigabit Ethernet with packet acceleration

End-to-end security from vehicle to cloud

- Embedded Hardware Security Module for cryptography and secure key management

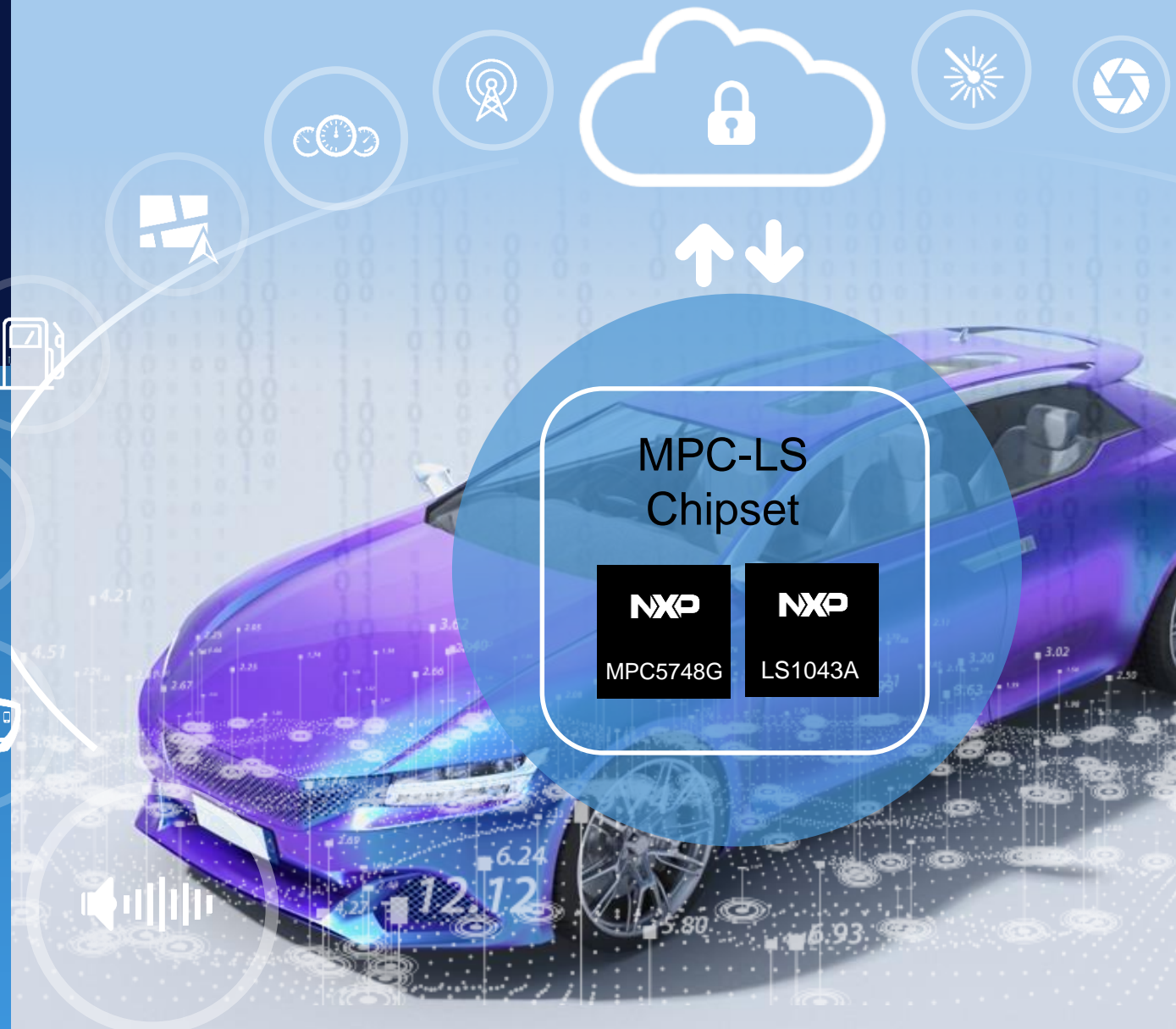

Bringing Together Automotive and Enterprise Networking to Enable Disruptive Opportunities

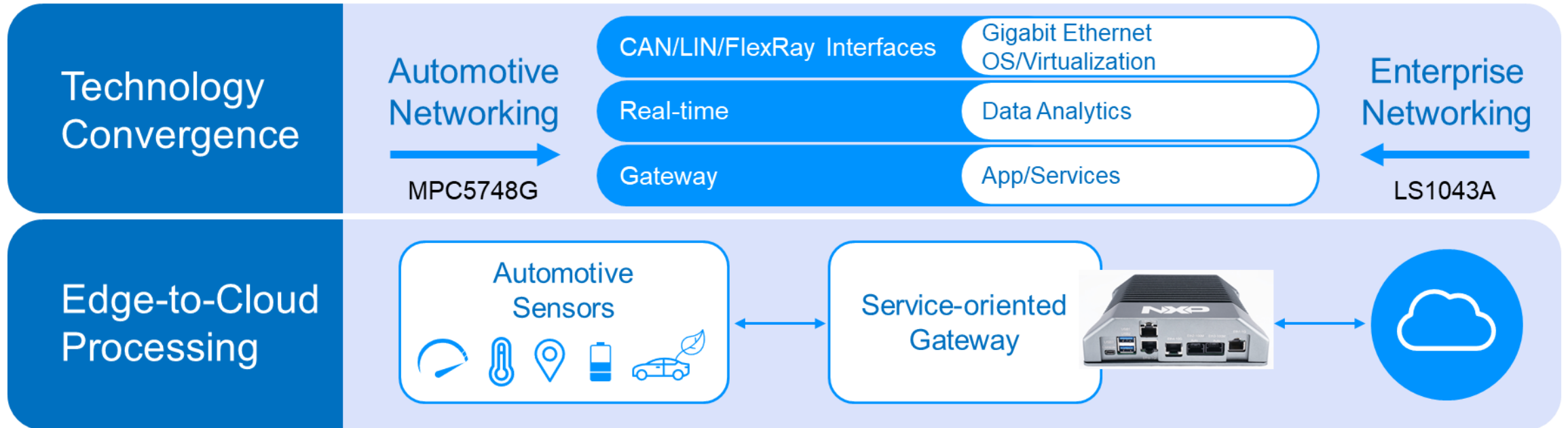

NXP MPC-LS Chipset Public Launch in February '19



NXP Enables Service-Oriented Gateways for Automakers to Unlock Value of Connected Vehicle Data

Automotive-grade chipset revolutionizes vehicle gateways with secure applications processing and network acceleration

f t in G+ p @ Email Print Friendly Share

February 26, 2019 02:00 ET | Source: NXP USA, Inc.

NUREMBERG, Germany, Feb. 26, 2019 (GLOBE NEWSWIRE) -- (Embedded World 2019) – NXP Semiconductors N.V. (NASDAQ: NXPI), the world's largest supplier of automotive semiconductors¹, today announced a **vehicle network processing chipset** solution for high-performance service-oriented gateways, which enables automakers to unlock the value of connected vehicle data and offer new services. The MPC-LS chipset solution combines the proven NXP automotive MPC5748G microcontroller and enterprise networking LS1043A communications processor to offer the high levels of performance and networking required for service-oriented gateways. For development, evaluation and demonstrations, the chipset solution is supported by an evaluation board, enablement software and a growing ecosystem.

Vehicle data-driven services such as usage-based insurance, predictive maintenance and over-the-air upgradeable vehicles are projected to reach up to \$750 billion in revenue by 2030². These services and the information derived from connected vehicles are poised to transform the automotive industry with new revenue opportunities, improved user experiences, safety and security enhancements and cost reductions. To enable these new opportunities, centrally located service-oriented gateways must securely process and route massive amounts of data across the vehicle, which requires a vehicle network processing solution to meet the demand.

NXP helps automakers, suppliers and emerging global entrants develop new vehicle networking platforms of the future today. The production-ready **MPC-LS vehicle network processing chipset** uniquely brings together real-time and applications processing, along with automotive and enterprise networking technologies.

Key features include:

- High-performance quad-core, 64-bit Arm® processors for services and edge analytics
- One 10 Gigabit and five Gigabit Ethernet interfaces for high-bandwidth networking
- Ethernet packet acceleration offloads processors to provide valued services
- Real-time processing of vehicle data from CAN FD, LIN and FlexRay™ networks
- Hardware security for trusted boot, cryptography and secure key management



Following

Our MPC-LS chipset is "a catalyst to unlock all the [#connectedvehicle](#) data that's going through the car." NXP's Brian Carlson talks to [@DesignNews](#) about helping automakers enable service-oriented gateways for new revenue streams, safety and more. [#EW19](#)



NXP Chipset Could Lay Foundation for New Services in the ...

Processors would enable faster communications, setting the stage for vehicles to use data in new ways.

[designnews.com](#)

10:09 AM - 26 Feb 2019



MPC-LS Vehicle Network Processing Solution

- Enables Next-gen CAN-Ethernet Gateways

- Automotive Gateway + Network Processing (Gigabit Ethernet Packet Routing) + Applications

- MPC5748G + LS1043A (MCU + MPU)

- Production chipset available today

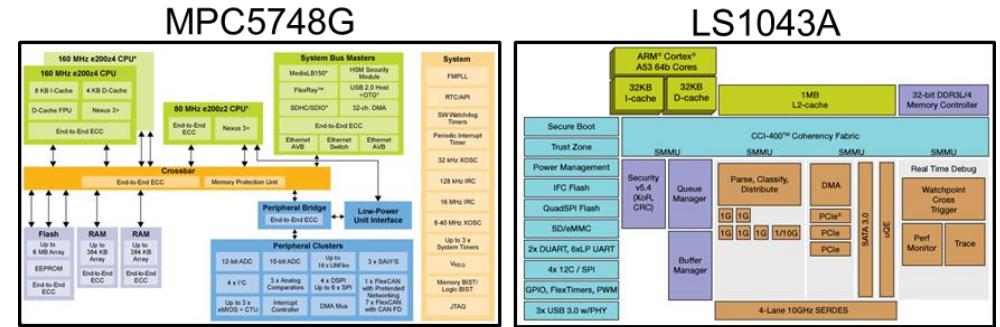

- Feature Set

- CAN Signal Gateway (MPC5748G)
- 4x Arm Cortex-A53 (LS1043A)
- Packet Forwarding Engine (DPAA Frame Manager)

- OS Support

- AUTOSAR: Real-time CAN gateway
- FreeRTOS (MPC5748G)
- Linux and QNX: Ethernet routing, applications processing

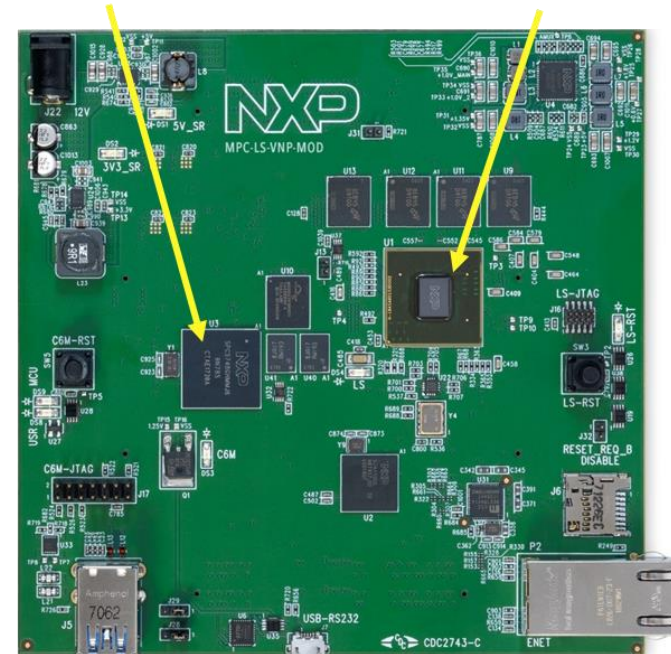

MPC5748G Automotive Gateway Microcontroller

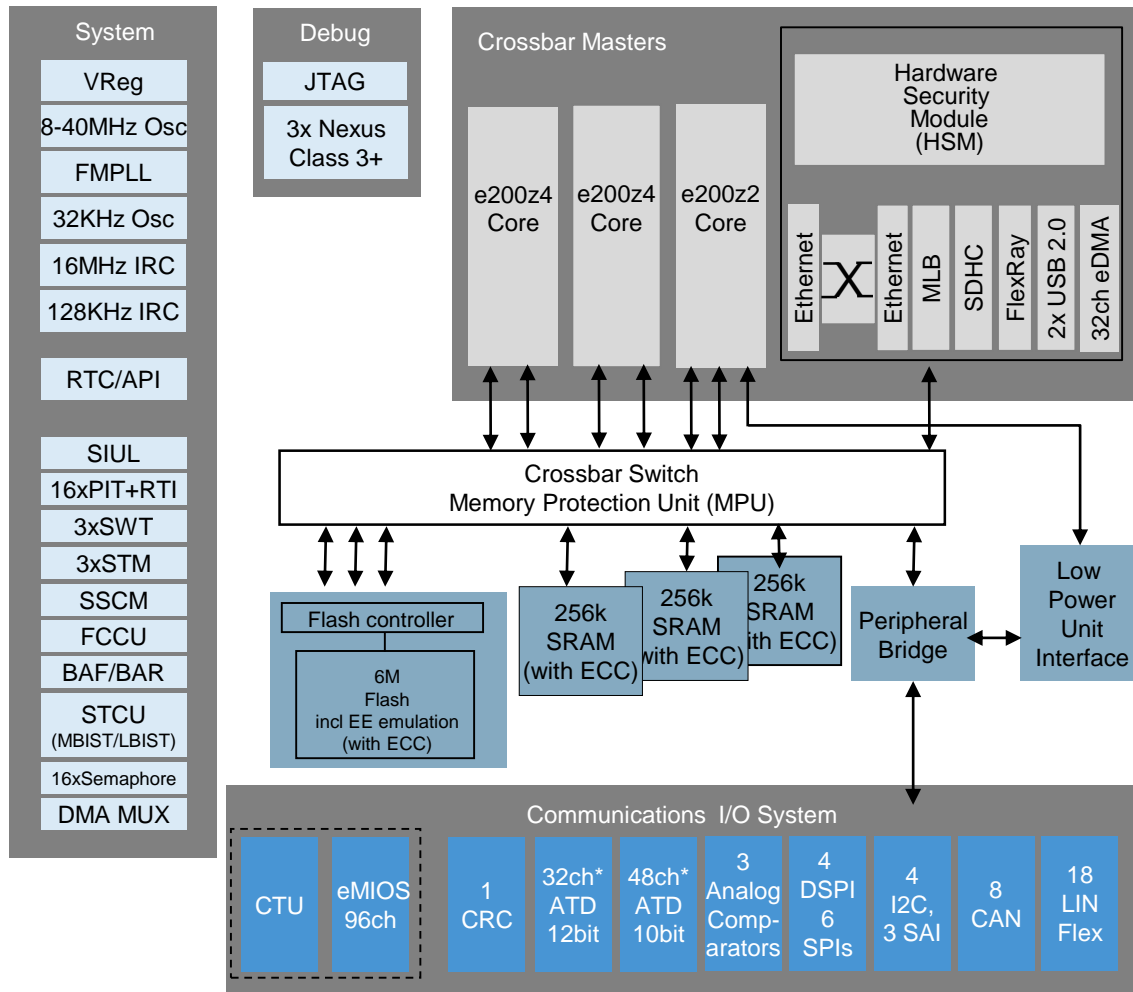

*Mixture of internal and external channels
Features (and quantity) depend on package and device version

Key Characteristics

- PowerPC Architecture: 2x e200z4 + 1x z2 cores, FPU on z4 cores
- 160 MHz max for z4s and 80 MHz on z2
- HSM Security Module supports both SHE and EVITA low/medium standard
- Media Local Bus supports MOST communication
- 2 x USB 2.0 (1 OTG and 1 Host module) support interfacing to 3G modem and infotainment domain
- Up to 2x Ethernet 10/100 Mbps RMII, MII, +1588, AVB (with Ethernet switch)
- CAN module supports CAN FD
- SDHC provides standard SDIO interface
- Low Power Unit provides reduced CAN, LIN, SPI, ADC functionality in low power mode
- Designed to ISO 26262 process for use in ASIL B
- Packages: 176 LQFP, 256 BGA, 324 BGA
- -40 to +125C (ambient)
- 3.0V to 5.5V

The NXP MPC5748G device provides real-time automotive networking and CAN gateway stack

LS1043A Network Processor

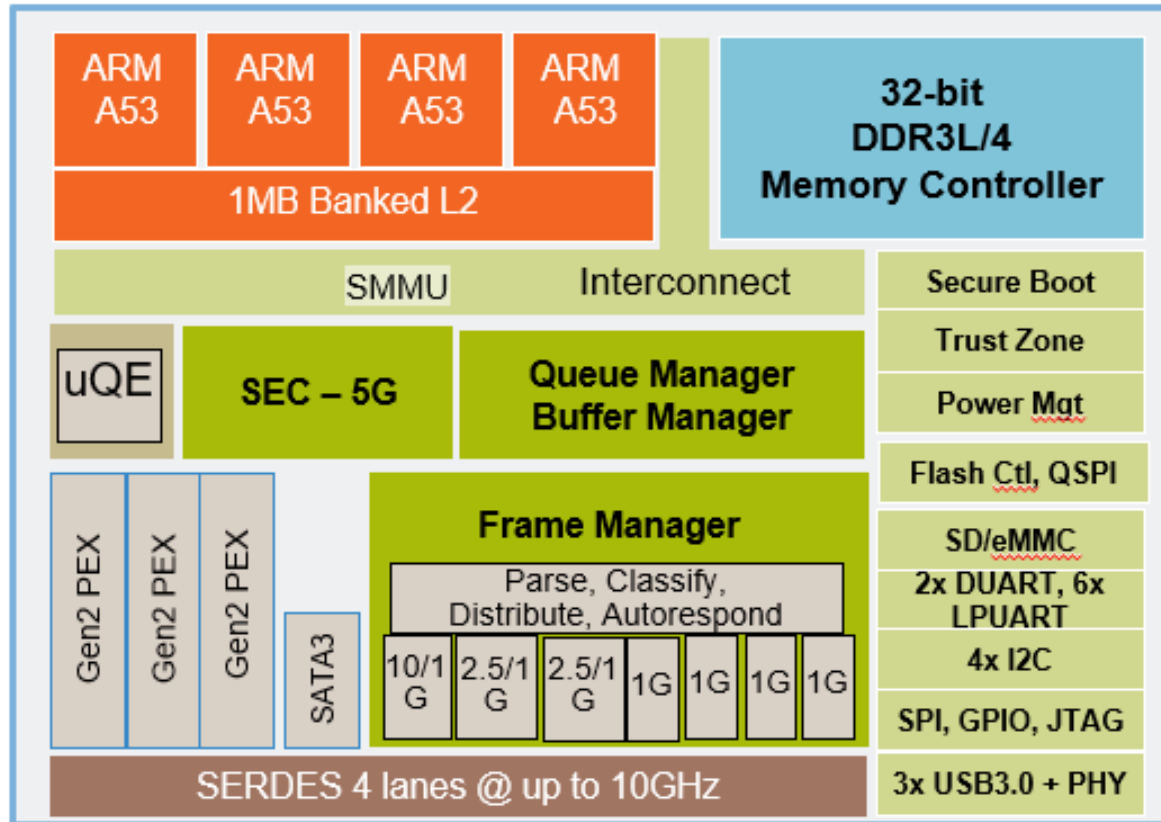

The NXP LS1043A device provides applications processing (services) and Ethernet packet routing acceleration

Key Characteristics

- 4x Arm Cortex-A53 @ up to 1.6 GHz
 - 19.5k DMIPS
 - SpecInt2k6 – 5.95, Rate -15
 - NEON SIMD in all CPUs
- 1x36b (including ECC) DDR3L/4 up to 1.6GT/s
 - 6.4GB/s memory BW
- High Speed IO
 - Multiple PCIe Gen2 controllers
 - Multiple Ethernet MACs (up to 10G)
- Security
 - 10Gbps Crypto Acceleration
 - IPsec, SSL
 - Trust Architecture
 - Secure Boot
 - Secure Debug
 - Secure Storage
 - Tamper Detection
 - HW Enforced Partitioning
 - ARM TrustZone
- Functional Safety:
 - ASIL B
 - ECC protected memories
 - Fault localization, containment and recovery
 - Soft lockstep with determinism
 - Excellent support for virtualization, containerization
- Package: 23x23mm, Unlidded FCBGA, .8mm pitch (780 pins)

Service-oriented Gateway Software Architecture

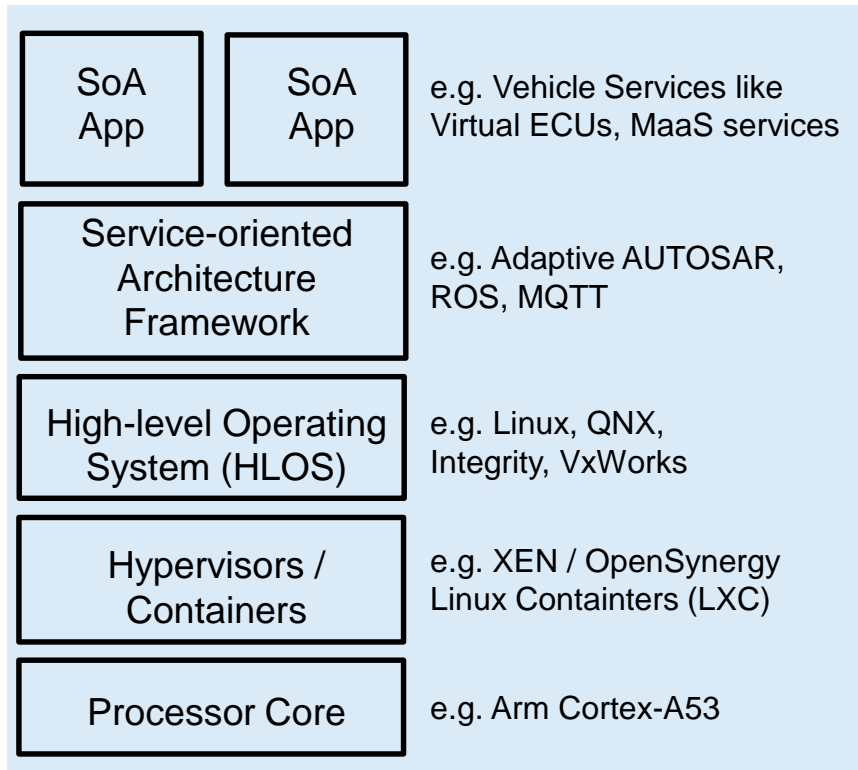

Service-oriented Architecture (SoA)

- SoA Apps are the “Services”
- Applications built with “service” layer of abstraction
- SoA App not bound to specific OS, SoC, or even ECU
- Framework supports dynamic deployment of services
- Simplifies Over-the-Air (OTA) updates
- Streamlines development and deployment of services
- T1s/OEMs develop/deploy a Service rather than an ECU

Service-oriented Architecture will Drive Rapid Innovation Deployment

Please attend AMF-AUT-T3657 - “Service-Oriented Architecture— Design and Implementation Using Automotive Linux BSP” for more details.

MPC-LS VNP System Solution

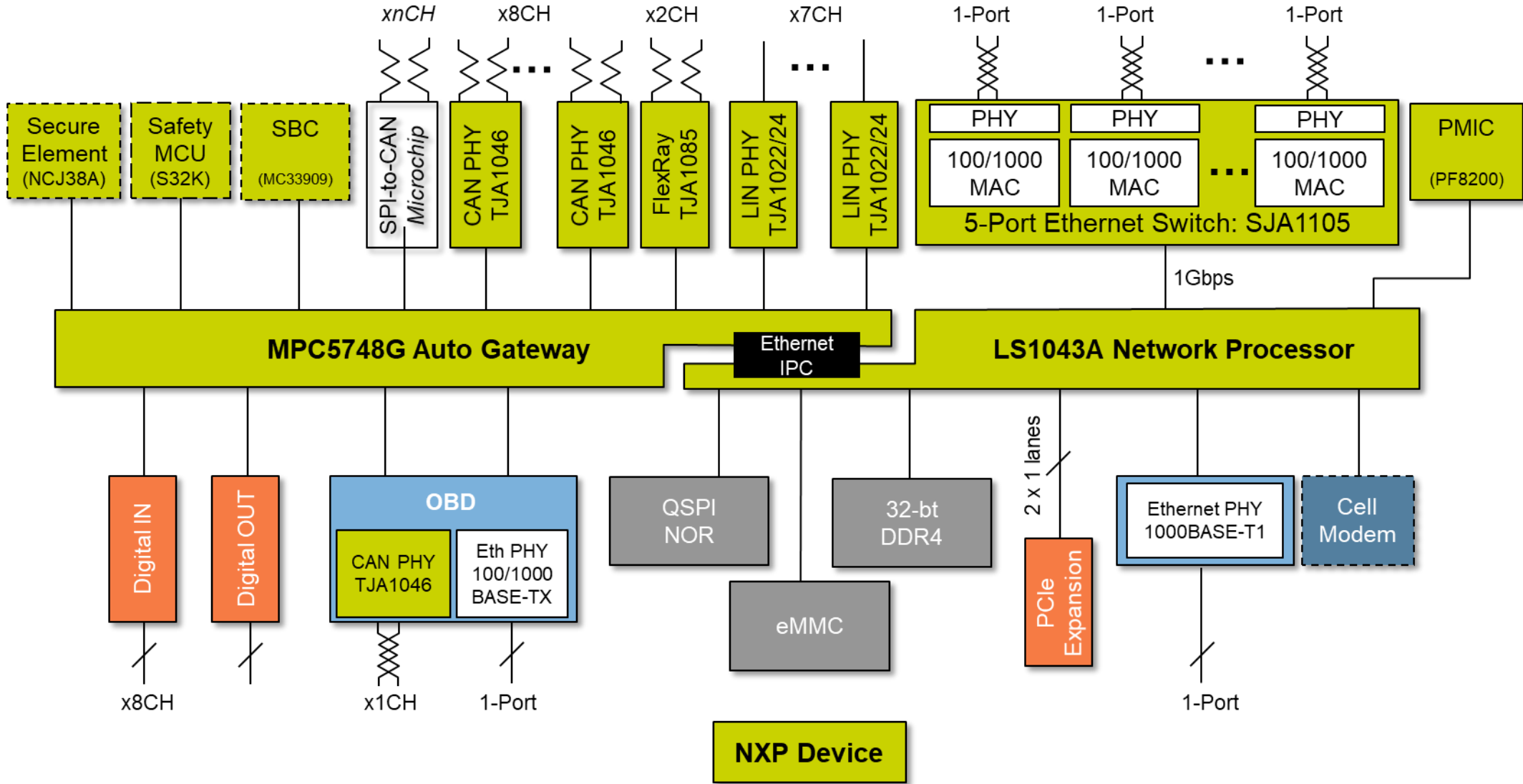

Big Data, Big Opportunities Today

- ✓ Evaluation Board (EVB)
- ✓ Reference Development Board (RDB)
- ✓ Software Enablement
- ✓ Demonstrations



Carmakers

Proof of concept
Benchmarking
Vehicle data insights
New services deployment

Application Developers

Innovation platform
Software development
Test and validation
Demo showcase

Cloud & Service Providers

Symbiotic compute
Over-the-Air (OTA) updates
Machine learning deployment
Edge service deployment

Accelerating Transformation Across the Automotive Ecosystem

MPC-LS Vehicle Network Processing (VNP) Evaluation Board (EDB)

- Real-time Gateway Processing
- Applications Processing
- Gigabit Ethernet Acceleration
- Embedded Security

Part Number: [MPC-LS-VNP-EVB](#)

- Price: \$2150 Available: Now for approved customers
- Designed for evaluation and demonstrations
- Includes SW enablement and demonstrations

NXP Components:

- MPC5748G (MCU), LS1043A (Comms Processor), SJA1105SEL (5-port Ethernet switch), PF8200 (Power Management IC)
- TJA1081TS (FlexRay), TJA1024HG (Quad LIN), TJA1044GT/3 (CAN HS), TJ1102HN (Dual Ethernet PHY), TJA1048T (Dual CAN), SJA1105QEL (5-port Ethernet Switch)
- MK26FN2MOVMI18 (Kinetis MCU-2MB for OpenSDA)
- NTS0102 (Dual-supply Transceiver), NX5P309UK (Power Switch)



www.nxp.com/MPC-LS-VNP-EVB

MPC-LS Vehicle Network Processing (VNP)

Reference Design Board (RDB)

- Real-time Gateway Processing
- Applications Processing
- Gigabit Ethernet Acceleration
- Embedded Security

Part Number: [MPC-LS-VNP-RDB](#)

- Price: \$749 Available: July'19 for approved customers
- Reference Design: 90% of BOM is Automotive Grade
- Includes SW enablement and demonstrations

NXP Components:

- MPC5748G (MCU), LS1043A (Comms Processor), SJA1105SEL (5-port Ethernet switch), PF8200 (Power Management IC)
- TJA1081TS (FlexRay), TJA1024HG (Quad LIN), TJ1102HN (Dual Ethernet PHY), TJA1048T (Dual CAN Transceiver)
- NTS0102 (Dual Supply Transceiver), NX5P3090UK (USB Power Switch)



www.nxp.com/MPC-LS-VNP-RDB

MPC-LS-VNP-RDB Key Features

MPC5748G Automotive Microcontroller

- ▶ AEC-Q100, Grade 2
- ▶ ISO 26262 ASIL B Functional Safety
- ▶ Processors
 - (2 x) Power Architecture® e200z4 @ 160 MHz
 - (1 x) Power Architecture e200z2 @ 80 MHz
- ▶ 6 MB embedded flash, 768 KB SRAM
- ▶ 8 x CAN FD + 4 (Non FD) w/SPI expansion
- ▶ 100 Mbps Ethernet, AVB
- ▶ 2 x FlexRay, 4x LIN
- ▶ Embedded hardware security module (HSM)
 - Supports SHE and EVITA standards

LS1043A Microprocessor

- ▶ (4 x) Arm® Cortex®-A53 64-bit processors
 - Up to 1.4 GHz
- ▶ Gigabit Ethernet data path acceleration
- ▶ 10 Gbit/s crypto acceleration

- ▶ 2 GB DDR3L @ up to 1.6 GT/s
- ▶ 8 Gbit NAND flash
- ▶ 512 Mb Serial NOR flash
- ▶ 8 Gbit eMMC
- ▶ 2 x 100 Mbit/s + 2 x 1Gbps + 1x 1/2.5/10 Gbps Ethernet, IEEE® 1588v2
- ▶ 3 x USB 3.0
- ▶ AEC-Q100, Grade 3 (Grade 2 available)

SJA1105 Automotive Ethernet Switch

- ▶ AEC-Q100, Grade 2
- ▶ SJA1105S: 3 x 100 Mbps + 2 x 1 Gbps ports
- ▶ 1024-entry MAC address learning table
- ▶ Hardware support for IEEE 802.1AS and IEEE 802.1Qav for AVB networks

Power Management IC

- ▶ PF8200 PMIC
- ▶ Configurable and programmable outputs to power the core processor, memory and a wide range of peripherals

Software

- ▶ MPC5748G: AUTOSAR® OS, MCAL, Bare-metal

- ▶ LS1043A: Linux® (Yocto 2.5), fast path packet forwarding
- ▶ Inter-platform communications framework (IPCF)
- ▶ Demo applications
 - Datalogging to cloud for vehicle health
 - Ethernet packet acceleration
 - Software-defined networking
- ▶ Certification: FCC Class B and CE

MPC-LS-VNP-RDB CONNECTORS

- ▶ MPC5748C Console
- ▶ USB 3.0 (x2)
- ▶ 1000BASE-TX (x4)
- ▶ Automotive 100BASE-T1 (x2)
- ▶ FlexRay (x2)
- ▶ LS1043A Console
- ▶ CAN/CAN FD (x12)
- ▶ LIN (x3)
- ▶ +12VDC Power Input

*Features available in RDB. Each device supports additional features.

MPC-LS-VNP-RDB Block Diagram

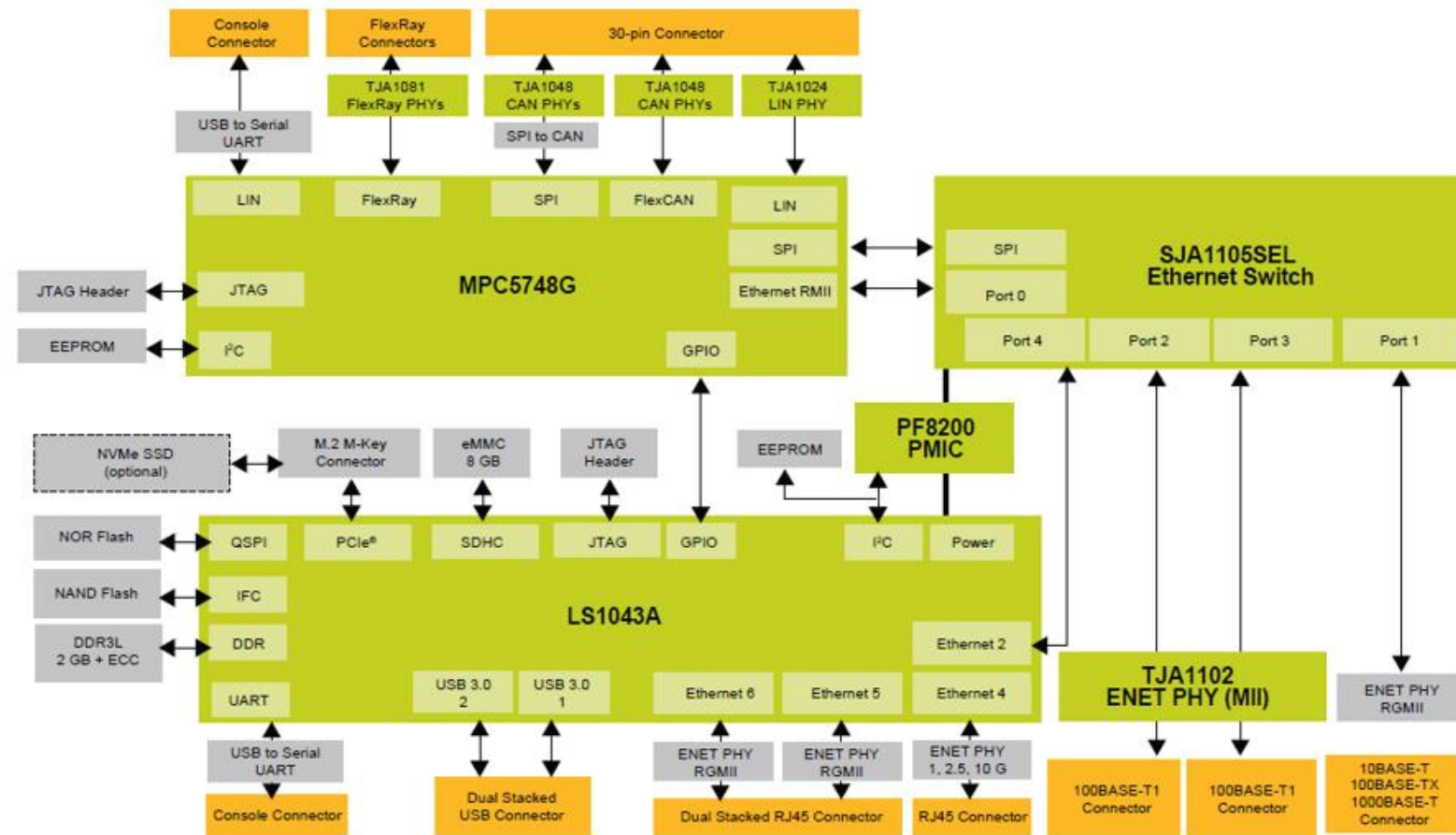

■ NXP Device

- **Processors**
 - MPC5748G Automotive Microcontroller
 - LS1043A Communications Processor
- **Memory**
 - 2 GB DDR3L @ up to 1.6 GT/s
 - 1 GB NAND flash
 - 64 MB Serial NOR flash
 - 8 GB eMMC
- **Storage**
 - M.2 M-Slot for optional PCIe SSD
- **NXP Support Devices**
 - PF8200 Power Management IC
 - SJA1105SEL Ethernet Switch
 - TJA1024 LIN PHY
 - TJA1048 CAN PHY
 - TJA1081 FlexRay PHY
 - TJA1102 100 Mbps Ethernet PHY
- **PCB**
 - Single 6-layer board ~ 6.1 x 6.4 inches
 - 90% of BOM Automotive Grade

MPC-LS VNP Reference Design Board Connectors



- MPC5748G Console
- USB 3.0 (x2)
- 10GBASE-T
- 1000BASE-TX (x3)
- Automotive 100BASE-T1 (x2)

- FlexRay (x2)
- LS1043A Console
- CAN/CAN FD (x12)
- LIN (x3)
- +12VDC Power Input

MPC-LS VNP Reference Design Board Key Components

LS1043A Console connector

Dual-stacked USB connector

RGMII EC1 and EC2 connector

Aquantia 10G connector

Auto Ethernet Port 1

Auto Ethernet Port 2

RGMII Ethernet PHY connected to SJA1105 switch

LS1043A

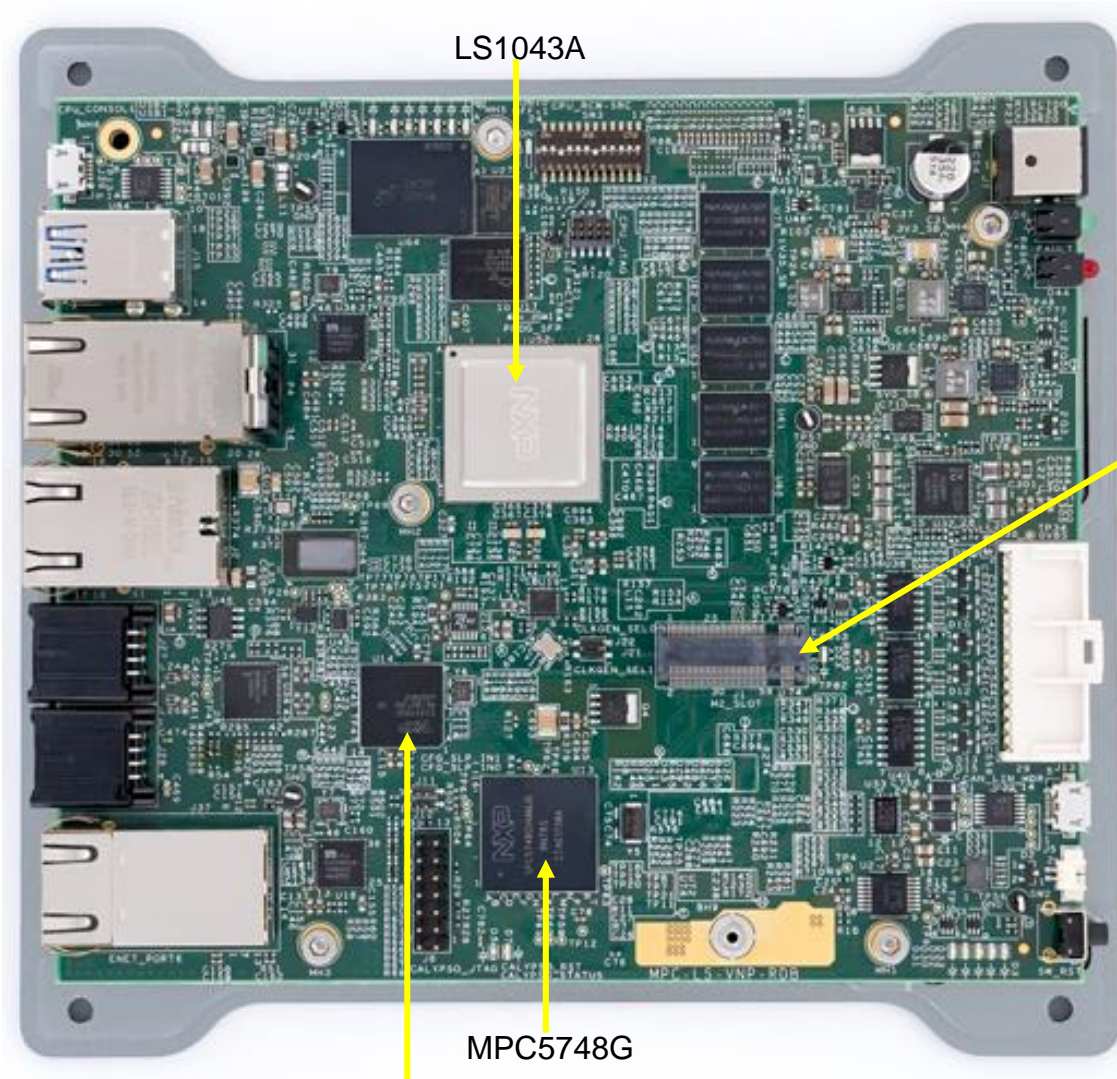

Power

Fault/Power LEDs

M.2 M-Key connector (PCIe) for SSD, peripherals

CAN connector

LIN connector

MPC5748G Console connector

FlexRay connector

Reset button

TJA1105S

MPC5748G

MPC-LS Demo Applications Software

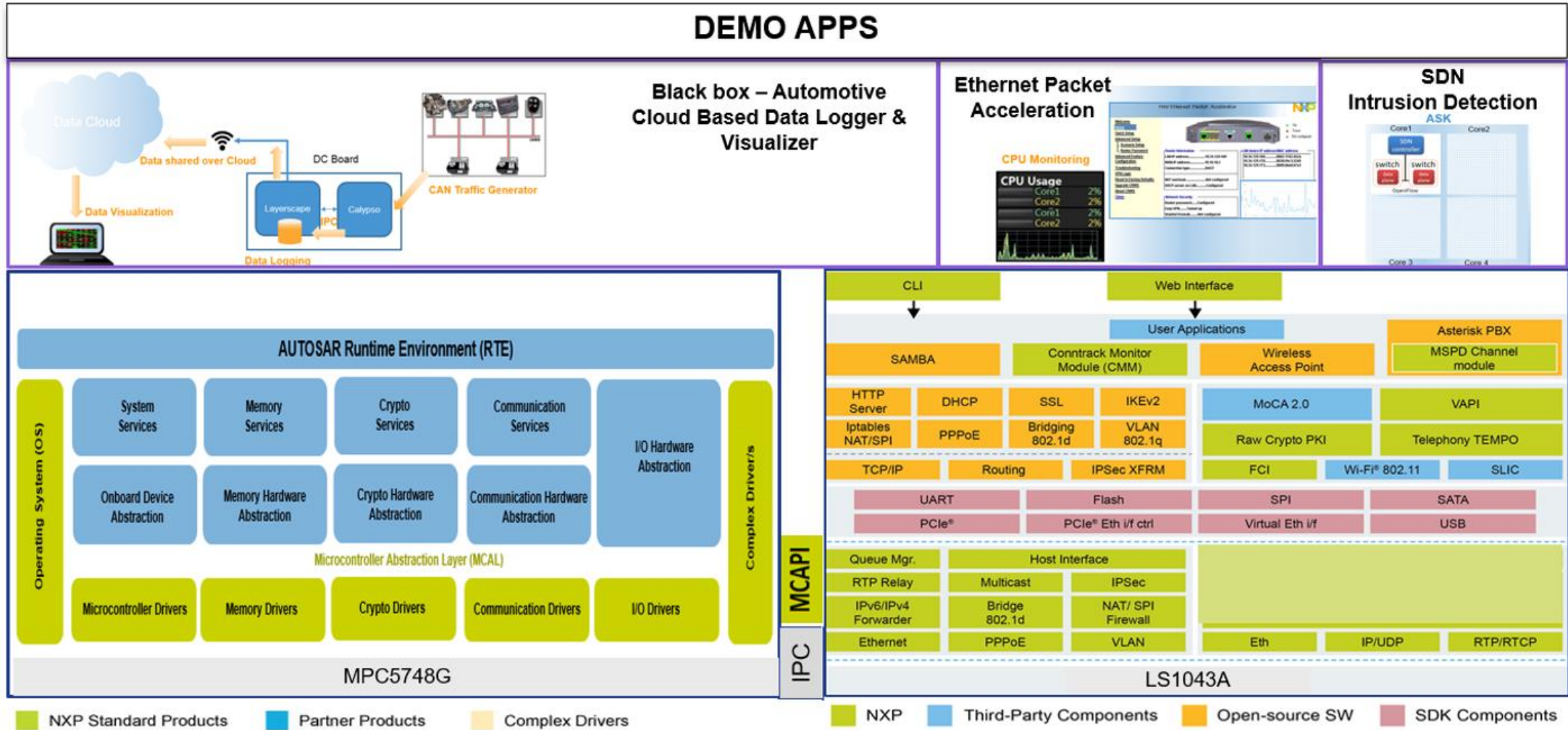

MPC-LS Vehicle Network Processing Ecosystem

Airbiquity & NXP Vehicle OTA & Data Management Service

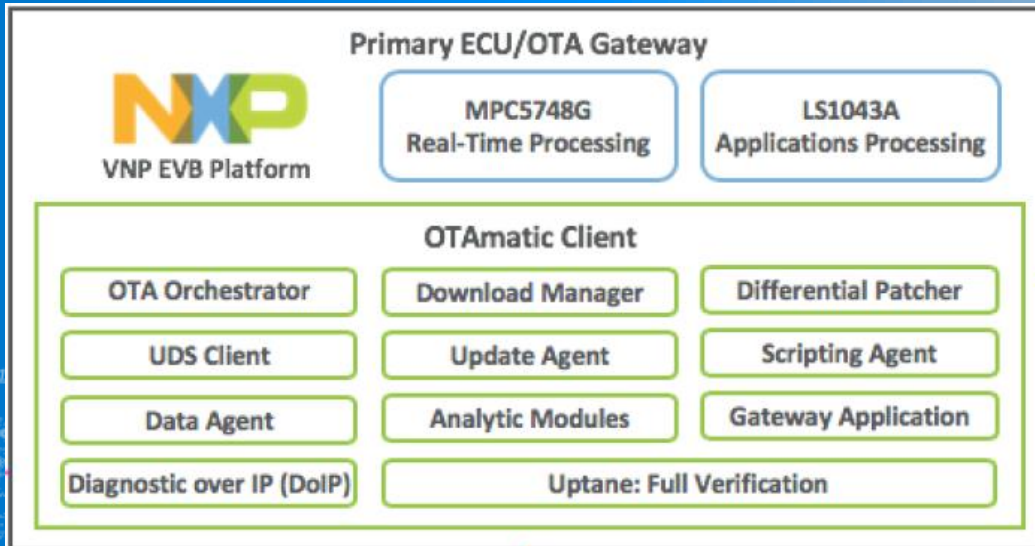

[Demo Spec Sheet](#)



MPC-LS Vehicle Network Processing Ecosystem

Cloudera & NXP Edge-to-Cloud Streaming Data Analytics

CLUDERA

See demo in the
Technology Lab
(Pedestal #209)

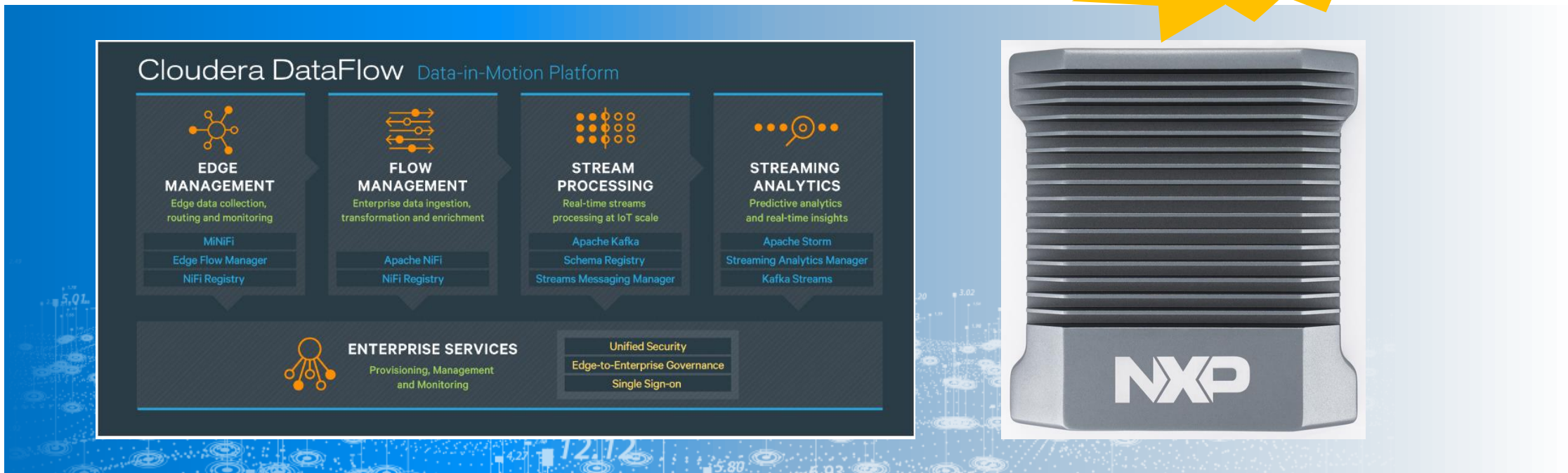

Vehicle Service-oriented Gateway Enables Opportunities

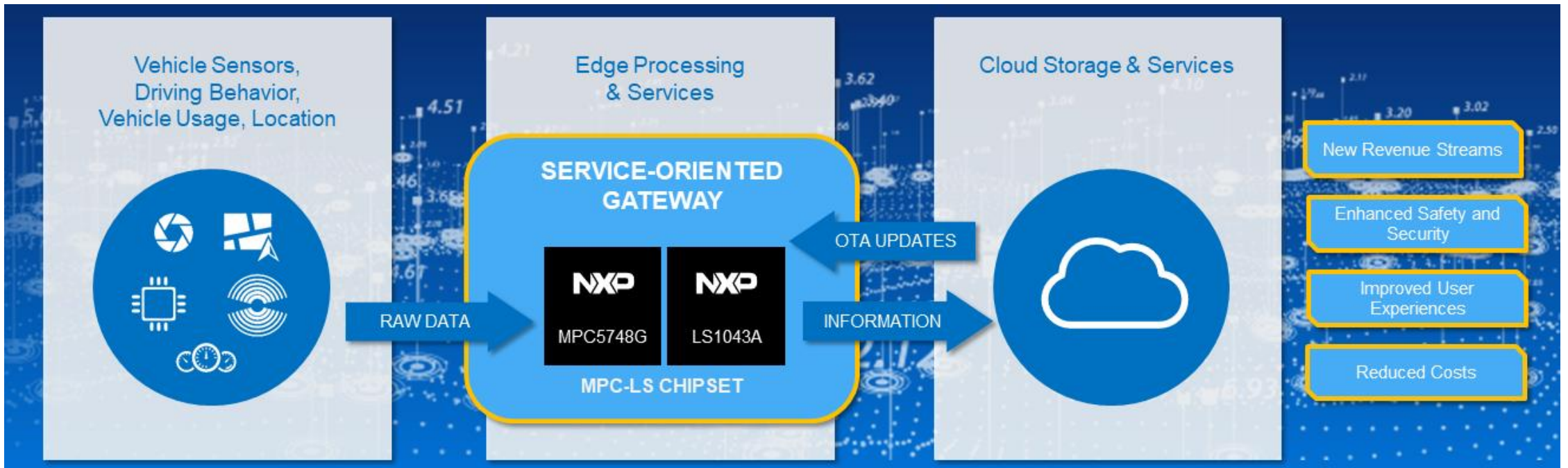

The NXP MPC-LS chipset enables service-oriented gateways

NXP Enables Service-Oriented Gateways for Automakers to Unlock Value of Connected Vehicle Data



- MPC-LS chipset combines proven NXP automotive microcontroller with enterprise networking communications processor
- Provides high level of performance and networking required for new Service-oriented Gateways
- Supported by reference design board, enablement software and growing ecosystem to accelerate product development
- Catalyst to unlock connected vehicle data for new opportunities that will transform the automotive industry

Related Presentations and Demo at NXP Connects

- **AMF-AUT-T3619** – “The Rise and Evolution of Gateways and Vehicle Network Processing”
- **AMF-AUT-T3662** – “Layerscape in Automotive—Multi-Arm Processors for Telematics, Gateway and AD Sensor Fusion”
- **AMF-AUT-T3657** – “Service-Oriented Architecture— Design and Implementation Using Automotive Linux BSP”
- **AMF-AUT-T3697** – “PF81/PF82 PMICs for High-Performance Applications Processors”
- **Demonstration – Technology Lab Kiosk #209** – “Unlocking Vehicle Data with the MPC-LS Chipset”



**SECURE CONNECTIONS
FOR A SMARTER WORLD**