

UM10384

UBA2028 CFL 18 W, 230 V dimmable reference board

Rev. 03 — 20 July 2010

User manual

Document information

Info	Content
Keywords	UBA2028, CFL, TRIAC dimmable, charge pump
Abstract	This document is a user manual for the 18 W, 230 V mains dimmable CFL reference board based on the NXP Semiconductors UBA2028.



Revision history

Rev	Date	Description
03	20100720	Third issue. Modifications: <ul style="list-style-type: none">• All illustrations updated to revised AQL standard.• Section 10 “Legal information” updated.
02	20100215	Second issue
01	20091014	First issue

Contact information

For more information, please visit: <http://www.nxp.com>

For sales office addresses, please send an email to: salesaddresses@nxp.com

1. Introduction

WARNING

Lethal voltage and fire ignition hazard



The non-insulated high voltages that are present when operating this product, constitute a risk of electric shock, personal injury, death and/or ignition of fire.

This product is intended for evaluation purposes only. It shall be operated in a designated test area by personnel that is qualified according to local requirements and labor laws to work with non-insulated mains voltages and high-voltage circuits. This product shall never be operated unattended.

The UBA2028 230 V mains dimmable reference board is a Compact Fluorescent Lamp (CFL) driver for a 18 W CFL burner. The maximum input power is 18 W, and it can be dimmed using a TRIAC dimmer. The dimming range reaches down to 10 % of light output.

2. Features

2.1 IC description

UBA2028 is a monolithic integrated circuit for driving electronically ballasted fluorescent lamps. The circuit is made in a 650 V Bipolar CMOS DMOS (BCD) power-logic process. It provides the drive function for the two discrete power MOSFETs. Besides the drive function, the IC also includes the level-shift circuit, the oscillator function, a lamp voltage monitor, a current control function, a timer function and protections.

The IC includes:

- Adjustable preheat time.
- Adjustable preheat current.
- Current controlled operating.
- Single ignition attempt.
- Adaptive non-overlap time control.
- Integrated high voltage level-shift function.
- Power-down function.
- Protection against lamp failures or lamp removal.
- Capacitive mode protection.

2.2 Board description

2.2.1 Specification

This user manual describes the design of a 230 V mains dimmable CFL ballast solution that may be employed in an already existing TRIAC based incandescent dimmer setup.

The disadvantage of normal electronic ballasts is that they cannot be dimmed with a standard phase cut type of dimmer.

This is because in TRIAC dimming, not only does the lamp current vary based on the TRIAC position but also the supply voltage variation. Typically the TRIAC conducts once it has been triggered and exceeds its latching current, and does not conduct when the current is less than the holding current. The dimmer works fine with a resistive load, such as an incandescent lamp. The TRIAC can be triggered at any timing of the sinusoidal voltage (AC line input), and can be kept in conduction state until it reaches zero line voltage.

The dimmer solution is based on the UBA2028, which can be designed into a ballast application such that the load is dimmable with a standard (phase cut) type of dimmer.

The board is designed to drive a 18 W CFL burner for 230 V (AC) mains input. The 230 V (AC) reference board, it consists of an AC mains input filter, a rectifier, a TRIAC dimmer position detector, the lamp current detector, half-bridge resonant tank and the charge pump circuit.

3. Circuit diagram

The circuit diagram is shown in [Figure 1](#)

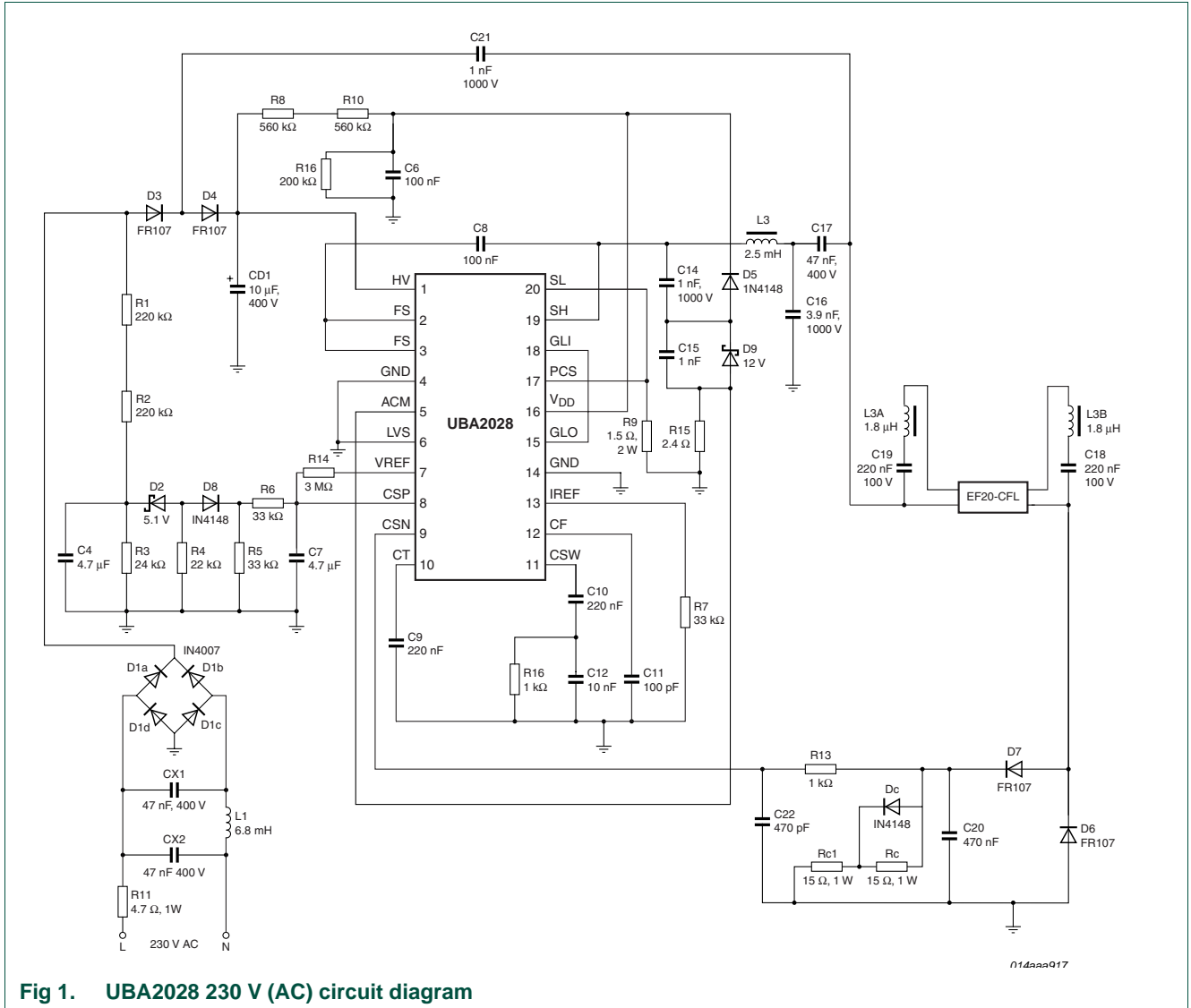

4. Board connection

The 230 V (AC) mains input connection and four CFL connections for the burner is connected as shown in [Figure 2](#). A resistor of 4.7 Ω is placed in series with the 230 V mains input.

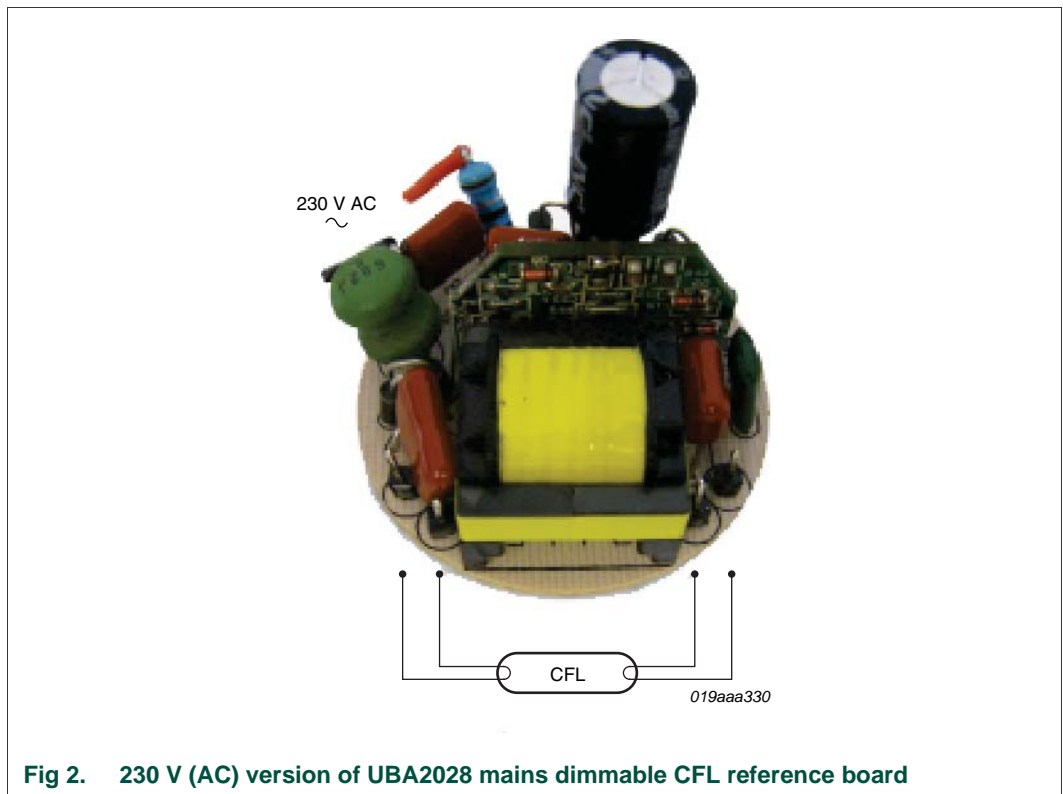

Fig 2. 230 V (AC) version of UBA2028 mains dimmable CFL reference board

The 230 V (AC) mains dimmable CFL reference board based on the UBA 2028 consists of both main and plug-in boards. The plug-in board can either be connected to the main board by a socket connector, or can be soldered directly.

The AC mains input and burner connections are indicated in [Figure 1](#).

5. Circuit considerations

5.1 Preheat time selection

Preheat time can be adjusted by the capacitor C9 (CT pin) and the resistor R7 (IREF pin). R7 could be selected between:

$2.5 \text{ V} / 65 \text{ } \mu\text{A} = 38 \text{ k}\Omega$ and $2.5 \text{ V} / 95 \text{ } \mu\text{A} = 26 \text{ k}\Omega$ (the values 65 μA and 95 μA refer to the UBA2028 data sheet). Usually R7 is selected to be 33 k Ω .

Because R7 also defines f_{min} , it is advised to change C9 to adjust the preheat time. The preheat time equation is as follows:

$$T_{pr} = \frac{C9}{(330 \times 10^{-9})} \times \frac{R7}{(33 \times 10^3)} s$$

5.2 Preheat current selection

Preheat current can be adjusted by L3A, L3B, C19, C18 and R9. Reducing the value of R9 will increase filament preheat current, vice versa. For good ignition, it is recommended to maintain lamp preheat current according to the lamp specification. The number of turns in the auxiliary cathode inductor windings of the output inductor L3 should be chosen to provide sufficient preheat. The lamp filament (cathode) resistance over the range of dimming levels must be between 3 times and 5.5 times the resistance when cold.

5.3 Transformer selection

The transformer L3 for a dimmable application needs to supply enough current during low light output to maintain a constant mains derived DC voltage. The primary inductance is designed to allow a high peak ignition current without saturation. To minimize losses in the inductor multi-stranded wire should be used in combination with ferrite cores of sufficiently good quality. For this reference board, the primary inductance is 2.5 mH, and the secondary inductance, used for inductive preheating is 1.8 μ H. A simplification for inductor selection would be, for a lamp with a 10% higher power, simply reduce the coil value by 10%.

5.4 Charge pump and feedback capacitor selection

The charge pump capacitor is important for CFL dimming, without the charge pump capacitor the lamp could not be dimmed, the charge pump has two function: one is to pump power to the electrical capacitance at low dimming positions to prevent capacitive mode, another is to draw current from the dimmer, even for voltages approaching the zero crossing level as this is needed to maintain the hold current for TRIAC operation.

5.5 Input filter selection

Input filter components CX2, CX1 and L1 need select to filter output noise of dimmer to supply a smooth voltage to CSP pin, also it needs avoid resonance of dimmer and the system during whole dimming range. The input filter also need avoid EMI to interference the input power supply.

5.6 Burner filament current selection when a low light output is required

During low light output, because of very low current through burner, the filament temperature will go down. Under this condition, the electron emission temperature will not be enough, and not enough electrons will be emitted. So L3A, L3B, C19 and C18 need to support enough current (normally around 200 mA RMS) to the filament, in order to maintain filament temperature during low light output.

6. Measurements

Table 1. Dimming measurements using Norma D4000 power analyzer

Norma analyzer measurement	UBA2028 (no dimming)	UBA2028 (minimum dimming)
V_I (V RMS)	230	100
I_I (mA RMS)	155	105
PACT (W)	22	7
CFi	4.2	9
TDI	0.77	0.92
PF	0.62	0.65

For the UBA2028 with no dimming measurements, the Norma D4000 power analyzer was placed between the lamp and the mains and no TRIAC dimmer was used.

For the UBA2028 minimum dimming measurements, the Norma D4000 power analyzer was placed between the TRIAC dimmer and the lamp in order to measure PACT at minimum dimming level.

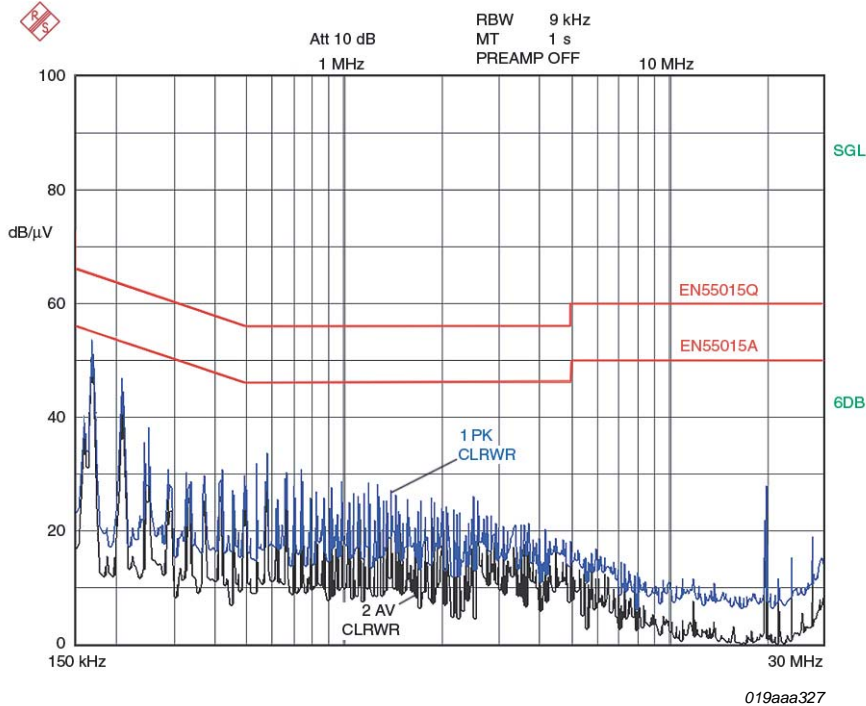

Fig 3. EMI measurement

6.1 I-transformer and V-burner under maximum and minimum light output

For dimmable applications, the burner selection is very important. When the burner is adjusted to a low light output, the burner voltage will go high, and the main voltage will go down due to the action of the TRIAC. Under these conditions, the resonant inductance needs a support current in order to maintain a smooth main DC voltage for the high voltage burner. When the high light output and the burner voltage change is not excessive when dimming to a low light output, the burner should have a voltage of approximately 100 V.

Figure 4 and Figure 5 show the measured waves of the I-transformer and V-burner with a suitable burner, under maximum and minimum light outputs. From these results, a small voltage change of the burner can be seen, and as the transformer current is less, the MOSFET will not be overloaded.

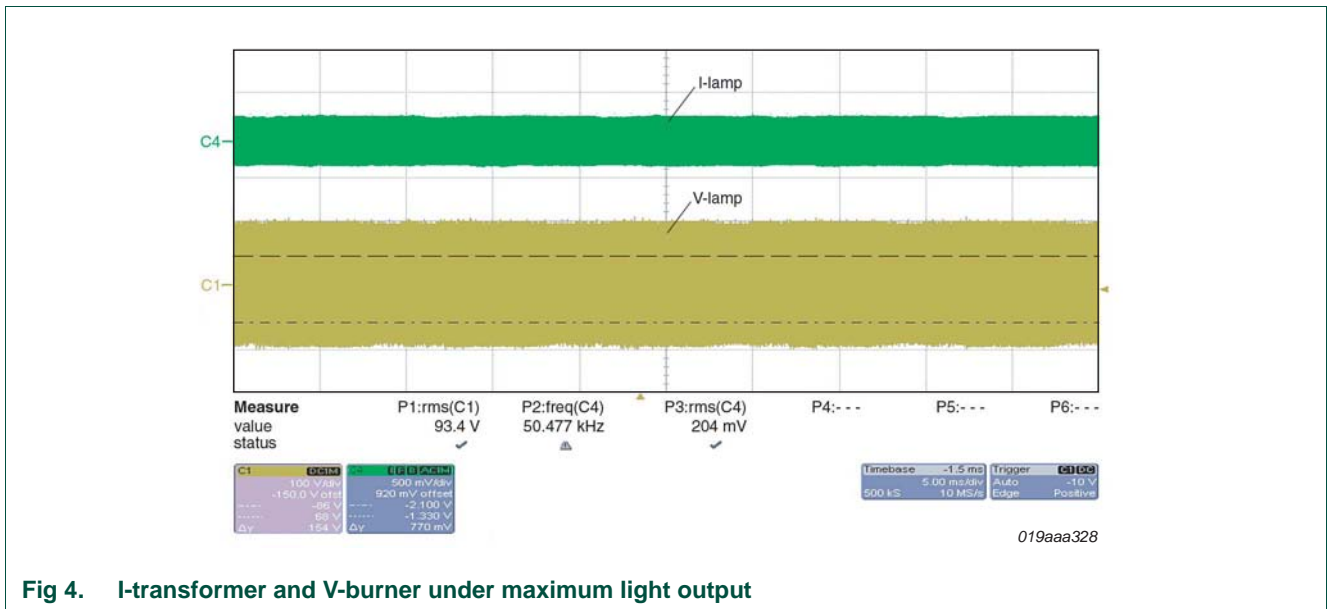

Fig 4. I-transformer and V-burner under maximum light output

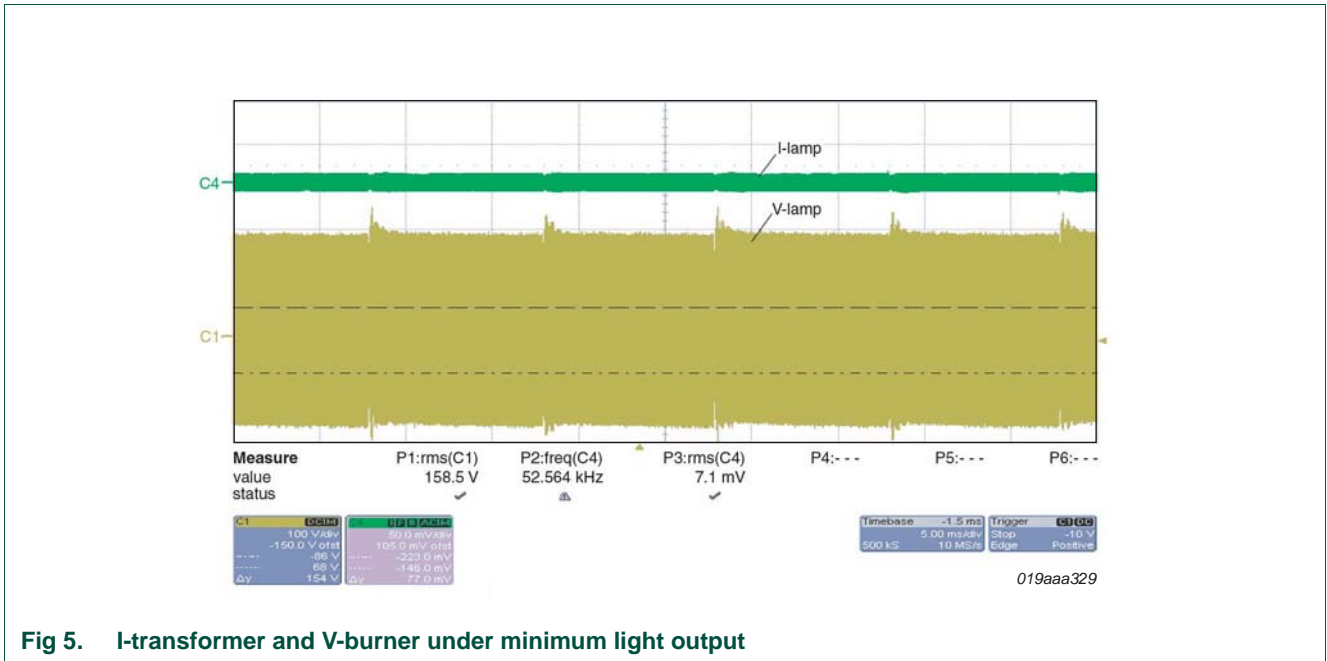

Fig 5. I-transformer and V-burner under minimum light output

7. Transformer specification

Figure 6 shows the transformer schematic:

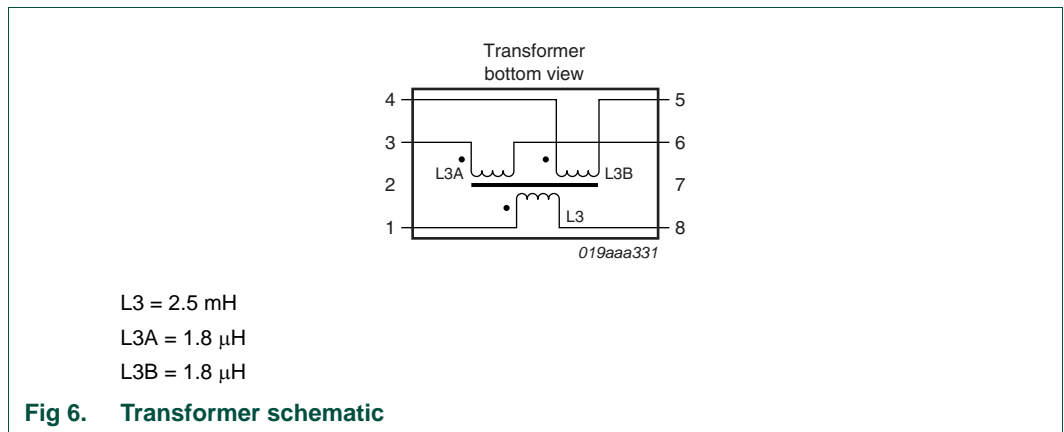

Fig 6. Transformer schematic

7.1 Electrical characteristics

Table 2. Inductance

Section	Inductance	Resistor
Primary	2.5 mH	7 Ω
Secondary	1.8 μH	180 mΩ

7.2 Core and bobbin

- Core size: EF20
- Core material: Philips 3C85, Siemens N27 or equivalent
- Gap length: 1.0 mm

8. Bill Of Materials (BOM)

The components used for the reference board are given in [Table 3](#)

Table 3. BOM

Designator	Part type	Description	Remarks
R11	4.7 Ω ; 1 W fusistor	fusistor resistor	fusistor
CD1	10 μ F; 400 V	electrical capacitance	high temperature electrical 105 $^{\circ}$ C
C21	1 nF; 1000 V	capacitance	charge pump capacitor
CX1	47 nF; 400 V	CBB capacitance	
CX2	47 nF; 400 V	CBB capacitance	
C17	47 nF; 400 V	CBB capacitance	
C16	3.9 nF; 1000 V	CBB capacitance	
L1	6.8 mH; R = 12 Ω	filter inductor	
L3	2.5 mH	lamp inductor	EF20 core
L3A	1.8 μ H	filament preheat inductor	EF20 core
L3B	1.8 μ H	filament preheat inductor	EF20 core
D1a to D1d	1N4007	diode	
D3	FR107	diode	
D4	FR107	diode	
D6	FR107	diode	
D7	FR107	diode	
SMD components			
R1	220 K Ω	resistor	
R2	220 K Ω	resistor	
R3	24 K Ω	resistor	
R4	22 K Ω	resistor	
R5	33 K Ω	resistor	
R6	33 K Ω	resistor	
R7	33 K Ω	resistor	
R8	560 K Ω	resistor	
R9	1.5 Ω ; 2 W	resistor	
R10	560 K Ω	resistor	
R13	1 K Ω	resistor	
R14	3 M Ω	resistor	
R15	2.4 Ω	resistor	
R16	1 K Ω	resistor	connected to pin CSW

Table 3. BOM ...continued

Designator	Part type	Description	Remarks
R16	200 K Ω	resistor	connected to pin 16
Rc	15 Ω ; 1 W	resistor	
Rc1	15 Ω ; 1 W	resistor	
C4	4.7 μ F; 50 V	capacitor	
C6	100 nF; 50 V	capacitor	
C7	4.7 μ F; 50 V	capacitor	
C8	100 nF; 50 V	capacitor	
C9	220 nF; 50 V	capacitor	
C10	220 nF; 50 V	capacitor	
C11	100 pF; 50 V	capacitor	
C12	10 nF; 100 V	capacitor	
C14	1 nF; 1 kV	capacitor	
C15	1 nF; 50 V	capacitor	
C18	220 nF 100 V	capacitor	
C19	220 nF; 100 V	capacitor	
C20	470 nF; 50 V	capacitor	
C22	470 pF; 50 V	capacitor	
D2	BZV55; 5.1 V	Zener diode	
D5	1N4148	diode	
D8	1N4148	diode	
D9	BZV55; 12 V	Zener diode	
Dc	1N4148	diode	
-	EF20 CFL; 18 W, 150 V RMS	EFL	
-	UBA2028T	IC	NXP Semiconductors

9. Appendix PCB layout

Figure 7 and Figure 8 show the layout of the PCB.

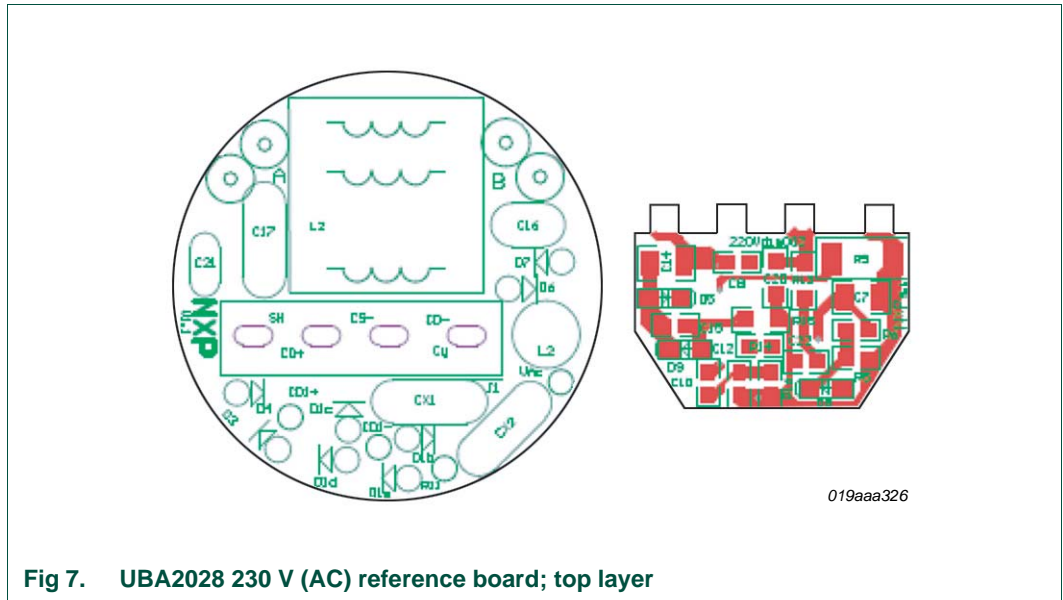

Fig 7. UBA2028 230 V (AC) reference board; top layer

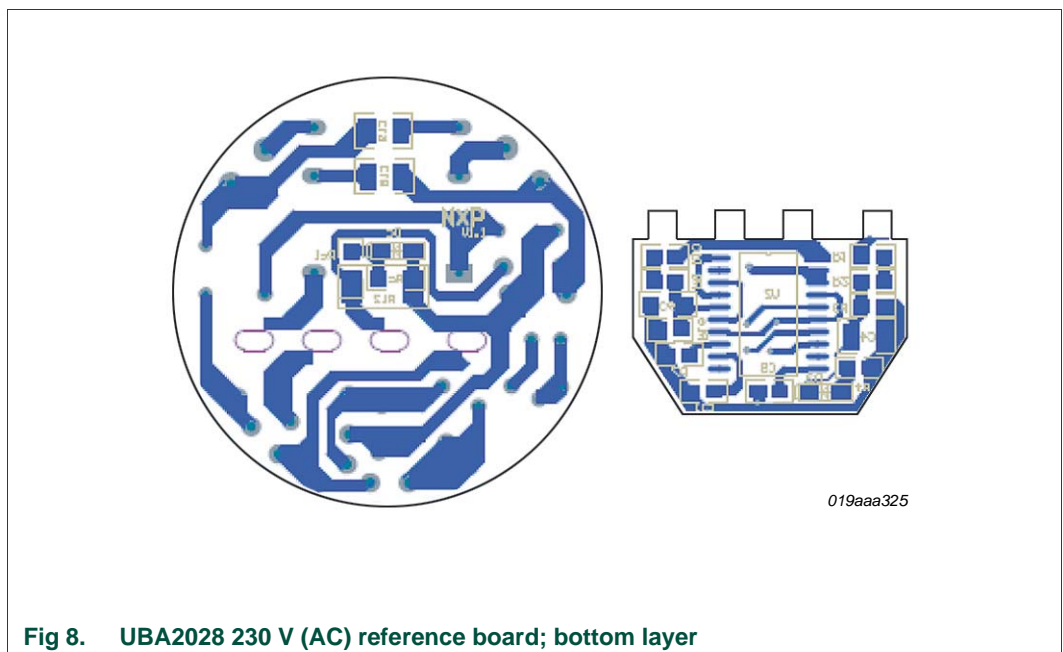

Fig 8. UBA2028 230 V (AC) reference board; bottom layer

10. Legal information

10.1 Definitions

Draft — The document is a draft version only. The content is still under internal review and subject to formal approval, which may result in modifications or additions. NXP Semiconductors does not give any representations or warranties as to the accuracy or completeness of information included herein and shall have no liability for the consequences of use of such information.

10.2 Disclaimers

Limited warranty and liability — Information in this document is believed to be accurate and reliable. However, NXP Semiconductors does not give any representations or warranties, expressed or implied, as to the accuracy or completeness of such information and shall have no liability for the consequences of use of such information.

In no event shall NXP Semiconductors be liable for any indirect, incidental, punitive, special or consequential damages (including - without limitation - lost profits, lost savings, business interruption, costs related to the removal or replacement of any products or rework charges) whether or not such damages are based on tort (including negligence), warranty, breach of contract or any other legal theory.

Notwithstanding any damages that customer might incur for any reason whatsoever, NXP Semiconductors' aggregate and cumulative liability towards customer for the products described herein shall be limited in accordance with the *Terms and conditions of commercial sale* of NXP Semiconductors.

Right to make changes — NXP Semiconductors reserves the right to make changes to information published in this document, including without limitation specifications and product descriptions, at any time and without notice. This document supersedes and replaces all information supplied prior to the publication hereof.

Suitability for use — NXP Semiconductors products are not designed, authorized or warranted to be suitable for use in life support, life-critical or safety-critical systems or equipment, nor in applications where failure or malfunction of an NXP Semiconductors product can reasonably be expected to result in personal injury, death or severe property or environmental damage. NXP Semiconductors accepts no liability for inclusion and/or use of NXP Semiconductors products in such equipment or applications and therefore such inclusion and/or use is at the customer's own risk.

Applications — Applications that are described herein for any of these products are for illustrative purposes only. NXP Semiconductors makes no representation or warranty that such applications will be suitable for the specified use without further testing or modification.

Customers are responsible for the design and operation of their applications and products using NXP Semiconductors products, and NXP Semiconductors accepts no liability for any assistance with applications or customer product design. It is customer's sole responsibility to determine whether the NXP Semiconductors product is suitable and fit for the customer's applications and products planned, as well as for the planned application and use of customer's third party customer(s). Customers should provide appropriate design and operating safeguards to minimize the risks associated with their applications and products.

NXP Semiconductors does not accept any liability related to any default, damage, costs or problem which is based on any weakness or default in the customer's applications or products, or the application or use by customer's third party customer(s). Customer is responsible for doing all necessary testing for the customer's applications and products using NXP Semiconductors products in order to avoid a default of the applications and the products or of the application or use by customer's third party customer(s). NXP does not accept any liability in this respect.

Export control — This document as well as the item(s) described herein may be subject to export control regulations. Export might require a prior authorization from national authorities.

Evaluation products — This product is provided on an "as is" and "with all faults" basis for evaluation purposes only. NXP Semiconductors, its affiliates and their suppliers expressly disclaim all warranties, whether express, implied or statutory, including but not limited to the implied warranties of non-infringement, merchantability and fitness for a particular purpose. The entire risk as to the quality, or arising out of the use or performance, of this product remains with customer.

In no event shall NXP Semiconductors, its affiliates or their suppliers be liable to customer for any special, indirect, consequential, punitive or incidental damages (including without limitation damages for loss of business, business interruption, loss of use, loss of data or information, and the like) arising out of the use of or inability to use the product, whether or not based on tort (including negligence), strict liability, breach of contract, breach of warranty or any other theory, even if advised of the possibility of such damages.

Notwithstanding any damages that customer might incur for any reason whatsoever (including without limitation, all damages referenced above and all direct or general damages), the entire liability of NXP Semiconductors, its affiliates and their suppliers and customer's exclusive remedy for all of the foregoing shall be limited to actual damages incurred by customer based on reasonable reliance up to the greater of the amount actually paid by customer for the product or five dollars (US\$5.00). The foregoing limitations, exclusions and disclaimers shall apply to the maximum extent permitted by applicable law, even if any remedy fails of its essential purpose.

Safety of high-voltage evaluation products — The non-insulated high voltages that are present when operating this product, constitute a risk of electric shock, personal injury, death and/or ignition of fire. This product is intended for evaluation purposes only. It shall be operated in a designated test area by personnel that is qualified according to local requirements and labor laws to work with non-insulated mains voltages and high-voltage circuits.

The product does not comply with IEC 60950 based national or regional safety standards. NXP Semiconductors does not accept any liability for damages incurred due to inappropriate use of this product or related to non-insulated high voltages. Any use of this product is at customer's own risk and liability. The customer shall fully indemnify and hold harmless NXP Semiconductors from any liability, damages and claims resulting from the use of the product.

10.3 Trademarks

Notice: All referenced brands, product names, service names and trademarks are the property of their respective owners.

11. Contents

1	Introduction	3
2	Features	3
2.1	IC description	3
2.2	Board description	3
2.2.1	Specification	3
3	Circuit diagram	5
4	Board connection	6
5	Circuit considerations	6
5.1	Preheat time selection	6
5.2	Preheat current selection	7
5.3	Transformer selection	7
5.4	Charge pump and feedback capacitor selection	7
5.5	Input filter selection	7
5.6	Burner filament current selection when a low light output is required	7
6	Measurements	8
6.1	I-transformer and V-burner under maximum and minimum light output	9
7	Transformer specification	10
7.1	Electrical characteristics	10
7.2	Core and bobbin	11
8	Bill Of Materials (BOM)	11
9	Appendix PCB layout	13
10	Legal information	14
10.1	Definitions	14
10.2	Disclaimers	14
10.3	Trademarks	14
11	Contents	15

Please be aware that important notices concerning this document and the product(s) described herein, have been included in section 'Legal information'.

© NXP B.V. 2010.

All rights reserved.

For more information, please visit: <http://www.nxp.com>

For sales office addresses, please send an email to: salesaddresses@nxp.com

Date of release: 20 July 2010

Document identifier: UM10384