

Table of Contents

Page 1	Title, ToC, Rev History & Notes
Page 2	PWRIN & VDDIO
Page 3	PMIC_Ref
Page 4	PU, PGOOD and ENABLE
Page 5	Load Connectors & Feedback
Page 6	Efficiency filters & Headers
Page 7	KL25Z
Page 8	Jumpers, DNP & Switch Tables

Revisions			
Rev	Description	Date	Approved
X1	Initial schematic	08/21/2019	Guru K.
A	Format clean-up, Final Release	10/14/2019	Guru K.
AX1	Removed U8, changed R111, added class 2 R124	03/04/2020	Guru K.
B	Final Release	03/09/2020	Guru K.

KITPF5024FRDMEVM

**Notes and
documentation**

All the default jumper and solder short configurations are noted in the corresponding pages

		6501 William Cannon Drive West Austin, TX 78725-6598	
<small>This document contains information proprietary to NXP and shall not be used for engineering design, procurement or manufacture in whole or in part without the express written permission of NXP Semiconductors.</small>			
NXP SEMICONDUCTORS		Classification: Company Internal/Proprietary	
Designer: Guru Karthik	Drawing Title: KITPF5024FRDMEVM		
Drawn by: Diego Garay	Page Title: Title, ToC and Rev History		
Approved: Guru Karthik	Size: C	Document Number: SCH-46403-SPF-46403	Rev: B
Date: Monday, March 09, 2020	Sheet 1 of 8		

POWER GENERATION

INPUT SUPPLY

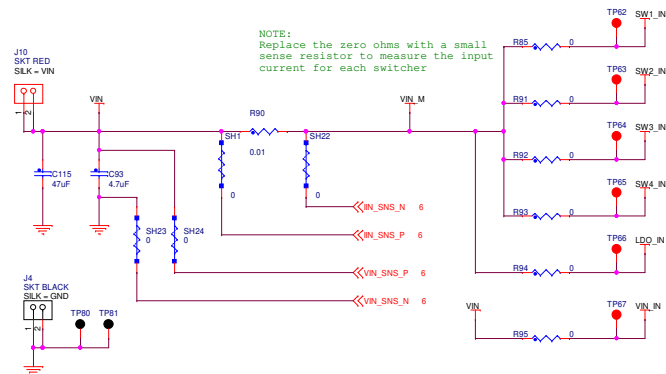

External VDDIO

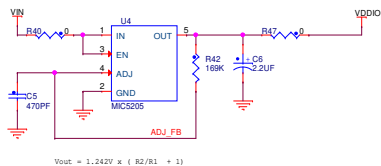

VDDIO VOLTAGE OPTIONS

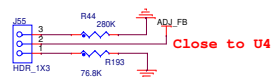

DEFAULT JUMPER SELECTION:
J55: 2-3



Classification: Company Internal/Proprietary		
Drawing Title: KITPF5024FRDMEVM		
Page Title: PWRIN and VDDIO		
Size C	Document Number SCH-46403; SPF-46403	Rev B
Date: Monday, March 09, 2020	Sheet 2	of 8

NOTE:
The zero ohms resistors and the solder shorts are used only on the EV board for debugging purposes

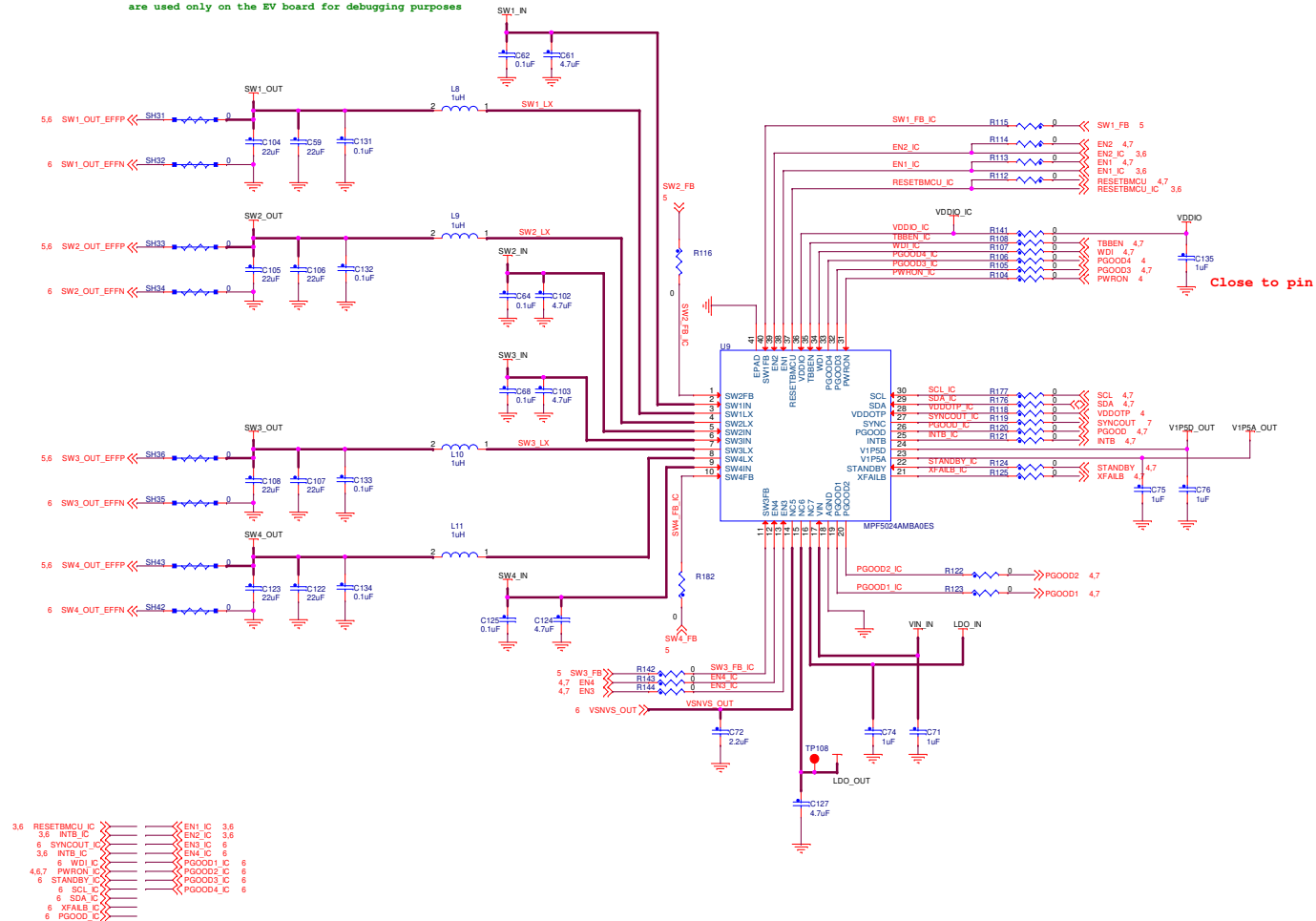

Classification: Company Internal/Confidential
Drawing Title: K1TF5024FRDMEVM

Page Title: PMIC_Reference_Schematic

Size C Document Number SCH-46403; SPF-46403 Rev B

Date: Monday, March 09, 2020 Sheet 3 of 8

PULL-UPS, POWER GOODS AND STATUS INDICATORS

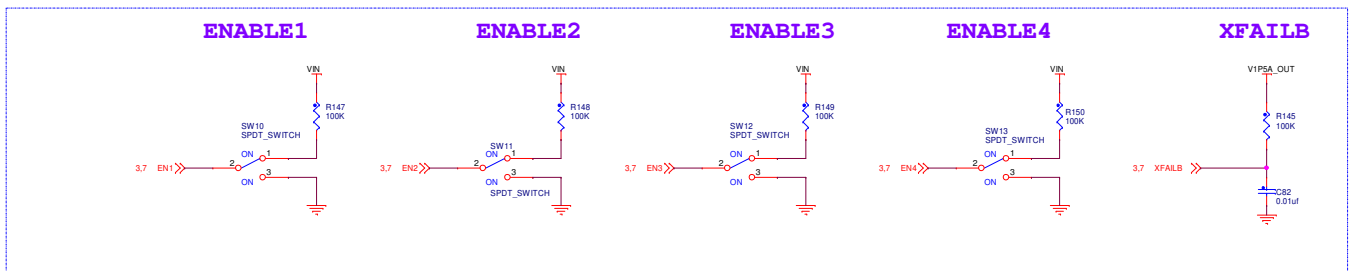
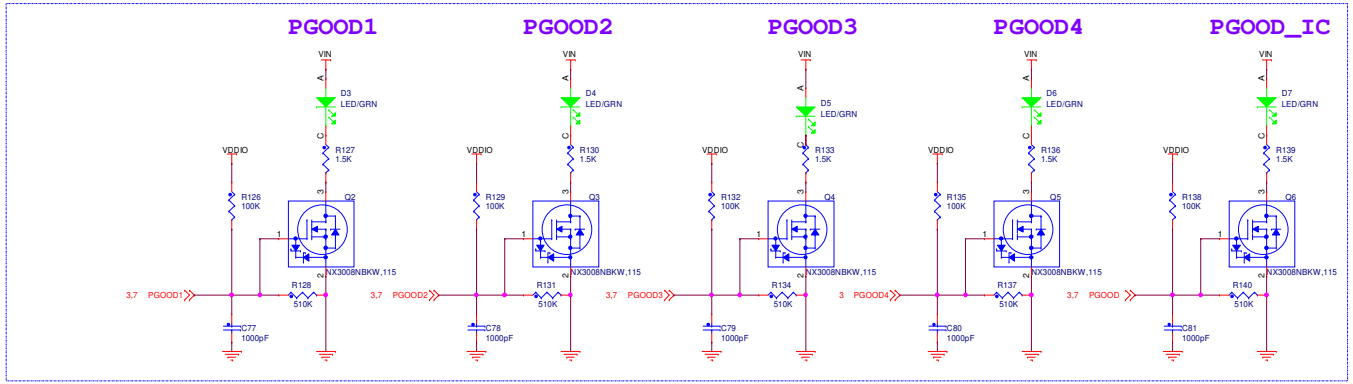
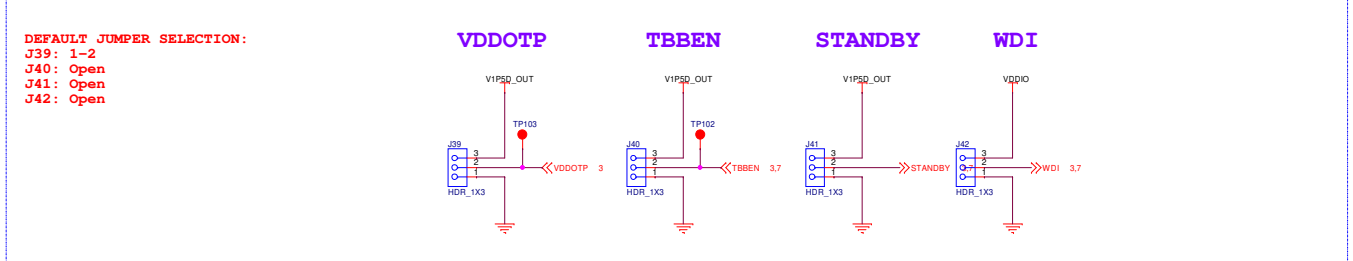
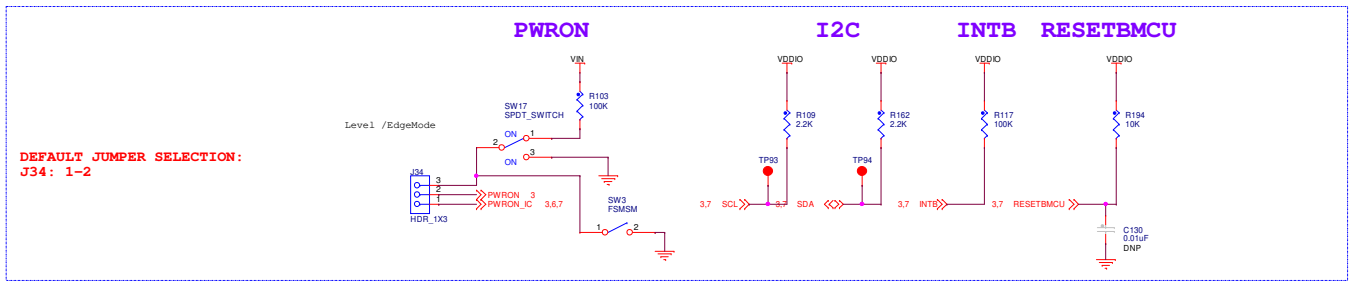



Classification: Company Internal/Proprietary		
Drawing Title: KITPF5024FRDMEVM		
Page Title: PU, PGOOD and ENABLE		
Size C	Document Number SCH-46403; SPF-46403	Rev B
Date: Monday, March 09, 2020	Sheet 4	of 8

LOAD CONFIGURATION

Dual phase options: Short SJ3 and SJ1, SJ4 and SJ6
Remove short on SJ2, SJ5

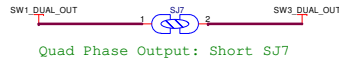
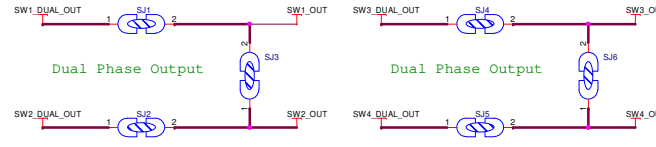

DEFAULT SOLDER BLOB
SELECTION: Short SJ1, SJ2, SJ4, SJ5

LOAD CONNECTIONS

Layout notes:
Place the resistors and the test points on the top
close to the load connectors

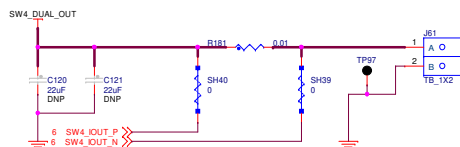
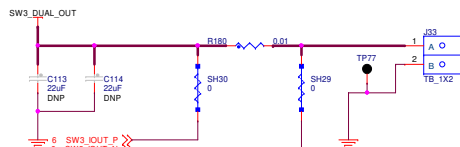
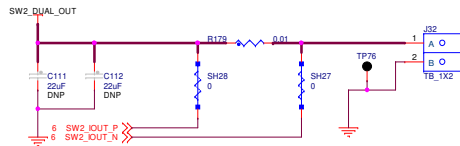
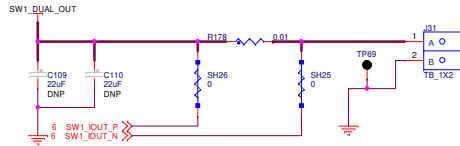

SW FEEDBACK OPTIONS

NOTE (review):
Use below TPs for stability measurement
TP109, TP110 (SW1)
TP111, TP112 (SW2)
TP113, TP114 (SW3)
TP117, TP118 (SW4)

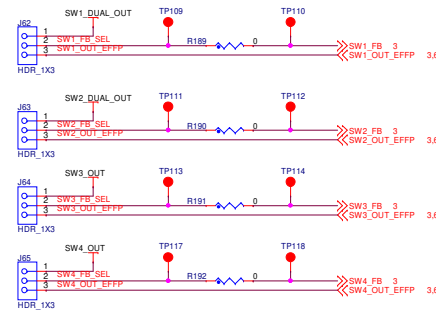

DEFAULT JUMPER SELECTION:
J62: 2-3
J63: 2-3
J64: 2-3
J65: 2-3



Classification: Company Internal/Proprietary		
Drawing Title: KITPF5024FRDMEVM		
Page Title: Load Connectors & Feedback		
Size C	Document Number SCH-46403; SPF-46403	Rev B
Date: Monday, March 08, 2020	Sheet 5 of 8	

PHASE VOLTAGE

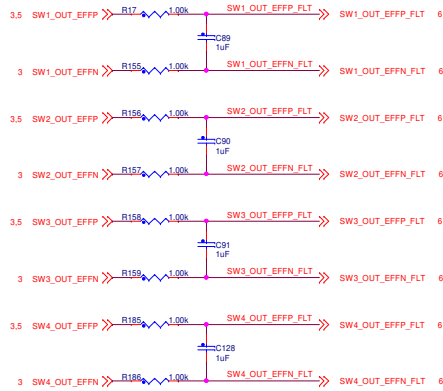

PHASE CURRENT

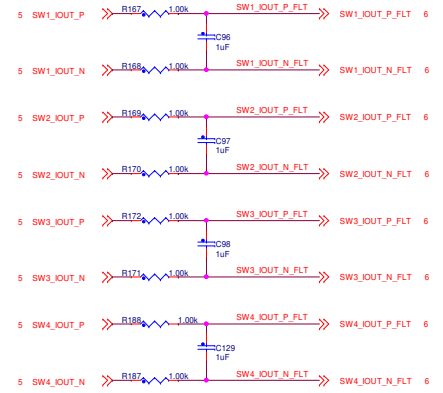

INPUT VOLTAGE & CURRENT

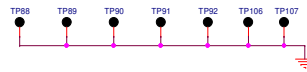
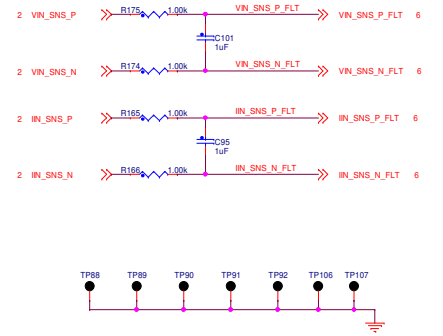

MASTER/SLAVE CONNECTOR

NOTE: Use single 12 Row connector to connect Slave side from primary EVB to Master side of 2nd EVB. Resistors can be configured on primary board for specific configurations.

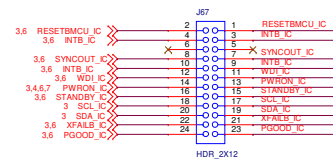

EFFICIENCY HEADER

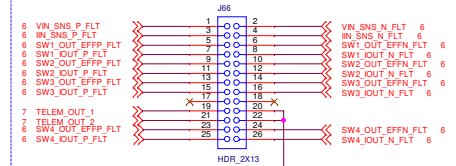

TEST POINTS AND TEST MODE HEADERS

JTAG



AMUX/DMUX

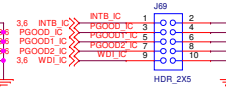

SIGNALS/POWER

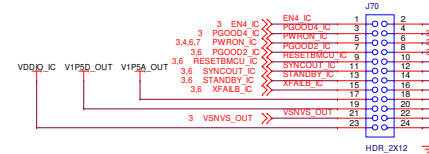

AMUX/DMUX

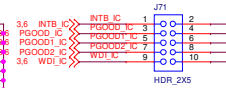

Classification: Company Internal/Proprietary
Drawing Title: **KITPF5024FRDMEVM**

Page Title: **Efficiency Filters_Headers**

Size C Document Number SCH-46403; SPF-46403 Rev B

Date: Monday, March 09, 2020 Sheet 6 of 8

KL25Z

KL25Z INTERFACE

Female connectors on the Freedom board with long pins, low insertion:
 SSQ-106-23-G-D / 210-80515
 SSQ-110-23-G-D / 210-80513
 SSQ-108-23-G-D (x2) / 210-80247

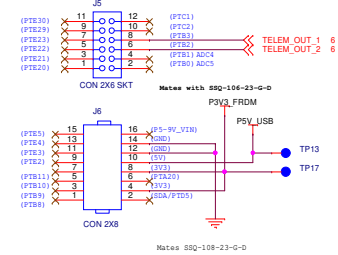
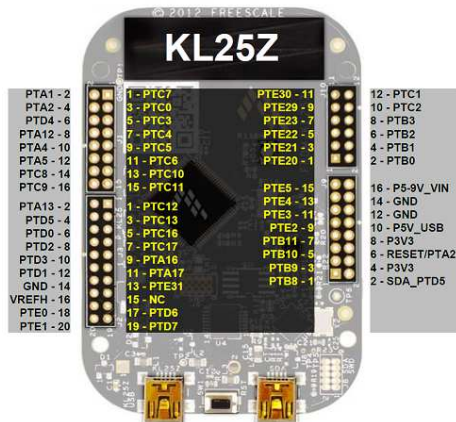
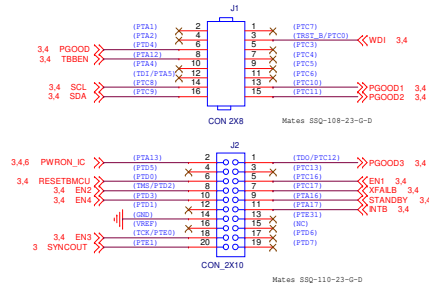



Classification: Company Internal/Proprietary
 Drawing Title: **KITPF5024FRDMEVM**

Page Title: **KL25Z**

Size C	Document Number SCH-46403; SPF-46403	Rev B
Date: Monday, March 09, 2020	Sheet 7 of 8	

REF DES	JUMPER(DEFAULT)	PAGE NAME
J55	2-3	02 - PWRIN & VDDIO
J34,J39	1-2	04 - PU, PGOOD and ENABLE
J41,J42,J40	Open	04 - PU, PGOOD and ENABLE
J64,J65,J63,J62	2-3	05 - Load Connectors & Feedback

REF DES	ASSY OPT	PAGE NAME
C68,C64	DNP	03 - PMIC Reference
R135,C130	DNP	04 - PU, PGOOD and ENABLE
C113,C109,C110,C111,C114, C112,C120,C121	DNP	05 - Load Connectors & Feedback

REF DES	SWITCH(DEFAULT)	SWITCH(OPTION1)	PAGE NAME
SW12,SW13,SW10,SW11,SW17	1-2: ENABLE VIN	2-3: ENABLE GND	04 - PU, PGOOD and ENABLE
SW3	OFF	ON	04 - PU, PGOOD and ENABLE



Classification: Company Internal/Confidential
Drawing Title: **KITPF5024FRDMEVM**

Page Title: **Jumper, DNP and Switch Tables**

Size	Document Number	Rev
C	SCH-46403; SPF-46403	B

Date: Monday, March 08, 2020 | Sheet 8 of 8